



Operating and Maintenance Instructions Manual

VE272SFS

Pipe/Tubing Roll Grooving Tool



⚠ WARNING



Failure to follow instructions and warnings could result in serious personal injury, property damage, and/or product damage.

- Before operating or servicing the VE272SFS Roll Grooving Tool, read all instructions in this manual and all warning labels on the tool.
- Wear safety glasses, hardhat, foot protection, and hearing protection.
- Save this operating and maintenance manual.

If you need additional copies of any literature, or if you have questions concerning the safe and proper operation of this tool, contact Victaulic Tool Company, P.O. Box 31, Easton, PA 18044-0031, Phone: 1-800-PICK VIC, e-mail: pickvic@victaulic.com.

INDEX

Hazard Identification	2
Operator Safety Instructions	3
Introduction	4
Receiving the Tool	4
VE272SFS Container Contents	5
Power Requirements	5
Power Drive	5
Extension Cord Requirements	5
Tool Nomenclature	6
Tool Setup	7
Pre-Operation Checks and Adjustments	11
Grooving Rolls	11
Pipe/Tubing Preparation	11
Groovable Pipe/Tubing Lengths	11
Short Pipe/Tubing Lengths	12
Long Pipe/Tubing Lengths	13
Roll Guard Adjustment	14
Pipe Stabilizer Adjustment	16
Groove Diameter Stop Adjustment	18
Grooving Operation	20
Roll Changing	23
Lower Roll Removal for 2-inch and Larger Sizes	24
Upper Roll Removal	25
Arbor Removal	26
Lower Roll/Adapter Assembly Installation for 3/4-inch and 1 – 1 1/2-inch Sizes	27
Upper Roll Installation	28
Lower Roll/Adapter Assembly Removal for 3/4-inch and 1 – 1 1/2-inch Sizes	29
Arbor Installation	29
Lower Roll Installation for 2-inch and Larger Sizes	30
Maintenance	32
Lubrication	32
Checking and Filling	
Hydraulic Systems	33
Air Bleeding	34
Parts Ordering Information	35
Accessories	35
VAPS 112 Victaulic Adjustable Pipe Stand	35
VAPS 224 Victaulic Adjustable Pipe Stand	35
VPD752 Power Drive	35
Stabilizer Assembly	36
Optional Rolls	36
Troubleshooting	37
Tool Rating and Roll Selection	39
Standard and “ES” Rolls for Steel and Stainless Steel Pipe – Color-Coded Black	39
Rolls for Aluminum and PVC Plastic Pipe – Color-Coded Yellow Zinc	40
RX Rolls for Schedule 5S and 10S Stainless Steel Pipe – Color-Coded Silver	41
Rolls for CTS US Standard – ASTM Drawn Copper Tubing – Color-Coded Copper	42
Rolls for European Standard – EN 1057 Drawn Copper Tubing – Color-Coded Copper	42
Rolls for Australian Standard – AS 1432 Drawn Copper Tubing – Color Coded Copper	43
Explanation of Critical Roll Groove Dimensions	44
Roll Groove Specifications	45
Steel, Stainless Steel, Aluminum, and PVC Pipe	45
Steel Pipe and All Materials Grooved with “ES” Rolls	47
Copper Tubing to CTS US Standard – ASTM B-88 and ASTM B-306	48
Copper Tubing to European Standard – EN 1057	49
Copper Tubing to Australian Standard – AS 1432	49
Facilities Locations	B/C

HAZARD IDENTIFICATION

Definitions for identifying the various hazard levels are provided below.



This safety alert symbol indicates important safety messages. When you see this symbol, be alert to the possibility of personal injury. Carefully read and fully understand the message that follows.

DANGER

- The use of the word “DANGER” identifies an immediate hazard with a likelihood of death or serious personal injury if instructions, including recommended precautions, are not followed.

WARNING

- The use of the word “WARNING” identifies the presence of hazards or unsafe practices that could result in death or serious personal injury if instructions, including recommended precautions, are not followed.

CAUTION

- The use of the word “CAUTION” identifies possible hazards or unsafe practices that could result in personal injury and product or property damage if instructions, including recommended precautions, are not followed.

NOTICE

- The use of the word “NOTICE” identifies special instructions that are important but not related to hazards.

OPERATOR SAFETY INSTRUCTIONS

The VE272SFS is designed only for roll grooving pipe/tubing. Use of this tool requires dexterity and mechanical skills, as well as sound safety habits. Although this tool is manufactured for safe, dependable operation, it is impossible to anticipate all the combinations of circumstances that could result in an accident. The following instructions are recommended for safe operation of this tool. The operator is cautioned to always practice "safety first" during each phase of use, including setup and maintenance. It is the responsibility of the owner, lessee, or user of this tool to ensure that all operators read this manual and fully understand the operation of this tool.

Read this manual before operating or servicing this tool. Become familiar with the tool's operations, applications, and limitations. Be particularly aware of its specific hazards. Store this manual in a clean area where it is always readily available. Additional copies of this manual are available upon request through the Victaulic Tool Company.

1. This tool is designed ONLY for roll grooving pipe/tubing sizes, materials, and wall thicknesses listed in the "Tool Rating and Roll Selection" section, starting on page 39.

2. Avoid using the tool in dangerous environments. Do not expose the tool to rain, and do not use the tool in damp or wet locations. Do not use the tool on sloped or uneven surfaces. Keep the work area well lit. Allow sufficient space to operate the tool properly.

3. Ground the power drive to protect the operator from electric shock. Make sure the power drive is connected to an internally grounded electrical source.

4. Prevent back injury. During tool setup, two people are needed to safely handle the tool head assembly. Use a hoist to lift the tool head assembly into position.

5. Inspect the equipment. Before using the tool, check all moveable parts for any obstructions. Make sure guards and tool components are installed and adjusted properly.

6. Prevent accidental startups. Place the switch on the power drive to the "OFF" position before plugging the unit into the electrical source.

7. Wear proper apparel. Do not wear loose clothing, jewelry, or anything that can become entangled in moving parts.

8. Wear protective items when working with tools. Always wear safety glasses, hardhat, foot protection, and hearing protection.

9. Stay alert. Do not operate the tool if you are drowsy from medication or fatigue. Avoid horseplay around the equipment.

10. Keep visitors away from the immediate work area. All visitors should be kept a safe distance from the equipment at all times.

11. Keep work areas clean. Keep the work area around the tool clear of any obstructions that could limit the movement of the operator. Clean up any oil or other spills.

12. Secure the work, machine, and accessories. Make sure the machine is stable. Refer to the "Tool Setup" section on page 7.

13. Support the work. Support long pipe/tubing lengths with a pipe stand that is secured to the floor or the ground.

14. Operate the tool only with a safety foot switch. The power drive must be operated with a safety foot switch that is located for easy operator access. Never reach across moving parts. If the power drive does not contain a safety foot switch, contact the power drive manufacturer.

15. Keep hands and tools away from grooving rolls and stabilizer wheel during the grooving operation. Grooving rolls can crush or cut fingers and hands.

16. Do not reach inside the pipe/tubing end during tool operation.

17. Do not over-reach. Maintain proper footing and balance at all times. Make sure the safety foot switch is easily accessible for the operator.

18. Do not force the tool. Do not force the tool or accessories to perform any functions beyond their capabilities. Do not overload the tool.

19. Do not operate the tool at speeds exceeding those specified in this manual.

20. Do not abuse the foot switch cord. Never yank the cord out of the receptacle. Keep the cord away from heat, oil, and sharp objects.

21. Unplug the power drive from the electrical source before servicing the tool. Only authorized personnel should attempt to perform maintenance on the tool. Always disconnect the power drive from the electrical source before servicing or adjusting the tool.

22. Maintain tools with care. Keep tools clean at all times to ensure proper and safe performance. Follow the instructions for lubricating tool components.

23. When tools are not in use, store them in a dry, secure place.

24. Use only Victaulic replacement parts and accessories. Use of any other parts may result in a voided warranty, improper operation, and hazardous situations. Refer to the "Parts Ordering Information" and "Accessories" sections on page 35.

25. Do not remove any labels from the tool. Replace any damaged or worn labels.

INTRODUCTION

NOTICE

- Drawings and/or pictures in this manual may be exaggerated for clarity.
- The tool, along with this operating and maintenance instructions manual, contains trademarks, copyrights, and/or patented features that are the exclusive property of Victaulic Company.

The Victaulic VE272SFS tool is a semi-automated, hydraulic feed tool for roll grooving pipe/tubing to receive Victaulic grooved pipe/tubing products. The standard VE272SFS tool is supplied with grooving rolls for 2 – 12-inch steel pipe. Rolls are marked with the size and part number, and they are color coded to identify the pipe/tubing material. For roll grooving to other specifications and materials, refer to the Tool Rating and Roll Selection on page 39. Grooving rolls for other specifications, sizes, and materials must be purchased separately.

CAUTION

- This tool must be used **ONLY** for roll grooving pipe/tubing designated in the "Tool Rating and Roll Selection" section of this manual. Failure to follow this instruction could overload the tool, resulting in reduced tool life and/or damage to the tool.

RECEIVING THE TOOL

VE272SFS tools are packed individually in sturdy containers, which are designed for use in re-shipping tools back to Victaulic upon completion of the rental contract, when applicable.

Upon receipt of the tool, make sure all necessary parts are included. If any parts are missing, notify the Victaulic Tool Company.

VE272SFS CONTAINER CONTENTS



Qty.	Description
1	Tool Head with Mounting Table
1	Upper Leg
2	Adjustable Legs
1	Hand Pump/Pump Support
2	Upper Rolls for 2 – 6-inch Steel Pipe and 8 – 12-inch Steel Pipe
3	“Keyless” Lower Rolls for 2 – 3-inch, 4 – 6-inch, and 8 – 12-inch Steel Pipe ‡
1	Guard Setting Pad
1	Lower Roll Removal Wedge
1	Can of Dry Graphite Spray
1	Pipe Tape
2	VE272SFS Operating and Maintenance Instructions Manual
1	RP-272SFS Repair Parts List

NOTE: Optional items, such as the stabilizer assembly, may be shipped separately.

‡ The 8 – 12-inch roll set is mounted on the tool head assembly at the factory.

POWER REQUIREMENTS

⚠ DANGER



- To reduce the risk of electric shock, check the electrical source for proper grounding.
- Before performing any maintenance on the tool, turn the switch on the power drive to the “OFF” position, or disconnect the power cord from the electrical source.

Failure to follow these instructions could result in death or serious personal injury.

POWER DRIVE

VE272SFS tools are designed for operation with a power drive. Tools mount directly onto a Victaulic VPD752 Power Drive or a Ridgid® 300 Power Drive with a 38-rpm maximum chuck speed.

Power must be supplied to the power drive through a safety foot switch to ensure safe operation. Make sure the power drive is properly grounded in accordance with Article 250 of the National Electrical Code.

If an extension cord is required, refer to the “Extension Cord Requirements” section on this page for cord sizes. In addition, refer to the power drive manufacturer’s instructions prior to use.

EXTENSION CORD REQUIREMENTS

When pre-wired outlets are not available and an extension cord must be used, it is important to use the proper cord size (i.e. Conductor Size American Wire Gauge). Cord size selection is based upon tool rating (amps) and cord length (feet). Use of a cord size (gauge) thinner than required will cause significant voltage drop at the power drive while the tool is operating. Voltage drops may cause damage to the power drive and can result in improper tool operation. **NOTE:** It is acceptable to use a cord size (gauge) that is heavier than required.

The required cord sizes (gauges) for cord lengths up to and including 100 feet (31 m) are listed in the table below. Use of extension cords longer than 100 feet (31 m) must be avoided.

Power Drive Rating Volts (Amps)	Cord Lengths		
	25 feet (8 m)	50 feet (15 m)	100 feet (31 m)
115 (15)	12 gauge	12 gauge	10 gauge

®Ridgid is a registered trademark of the Ridgid Tool Company.

TOOL NOMENCLATURE

NOTICE

- Drawings and/or pictures in this manual may be exaggerated for clarity.
- The tool, along with this operating and maintenance instructions manual, contains trademarks, copyrights, and/or patented features that are the exclusive property of Victaulic Company.

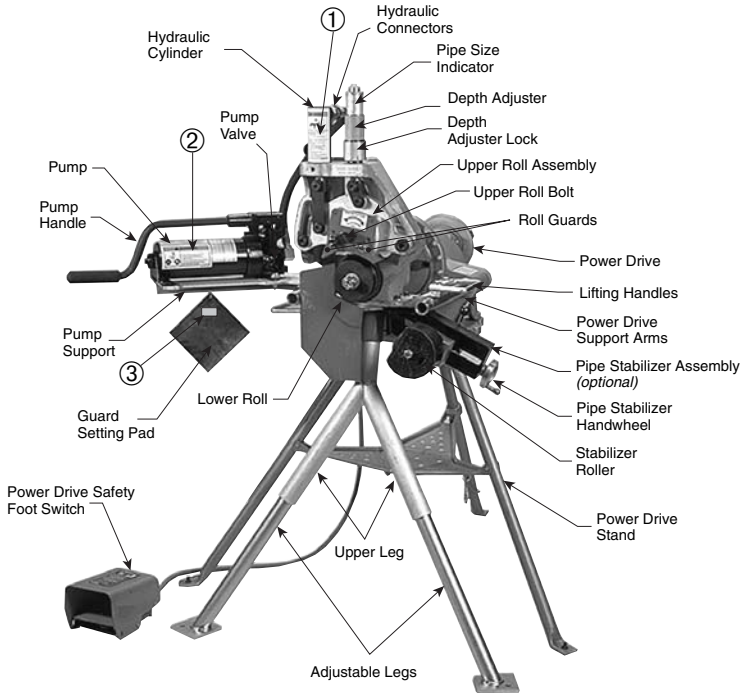

③

ALWAYS KEEP THIS PAD WITH THE TOOL. USE IT TO SET THE GUARDS IN ACCORDANCE WITH THE TOOL OPERATION AND MAINTENANCE MANUAL.

R068272LAB

②

WARNING

Failure to follow instructions and warnings can result in serious injury, property damage, or faulty installation.

- Before installing, operating, or servicing this tool, read and understand the Operating Instructions and all warning labels on this tool.

- Always wear safety glasses and foot protection.

If you have any questions about the safe operation of this tool, contact Victaulic Tool Company, P.O. Box 31, Easton, PA 18044-0031, 610-559-3300.



0567 Rev.A

R031272LAB 3/99

①

WARNING

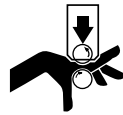

Grooving rolls can crush or cut fingers and hands.

- Always turn off power before adjusting guard.
- Be sure guard is properly adjusted before grooving pipe.
- Keep hands away from grooving rolls and stabilizer wheel.
- Never reach inside pipe end or across the tool or pipe during operation.
- Always groove pipe in a clockwise direction only.
- Never groove pipe shorter than what is recommended.
- Never wear loose clothing, loose gloves, or jewelry while operating tool.

0585

R033272LAB 9/94

TOOL SETUP

WARNING

- **DO NOT** plug the power drive into the electrical source until instructed otherwise. Accidental startup of the tool could result in serious personal injury.

WARNING

- During tool setup, two people are required to safely handle the tool head assembly.
 - Use a hoist to lift the tool head assembly into position.
- Failure to follow these instructions could result in serious personal injury.

The standard VE272SFS tool is intended for field or shop setup. Before grooving, the tool head assembly and legs must be mounted onto a Victaulic VPD752 Power Drive or a Ridgid 300 Power Drive with a 38-rpm maximum chuck speed.

1. Remove all components from the packaging, and make sure all necessary items are included. Refer to the "Receiving the Tool" section on page 4.
2. Select a location for the power drive, tool, and pipe stand by taking into consideration the following factors (refer to the drawing below for overall dimensions):

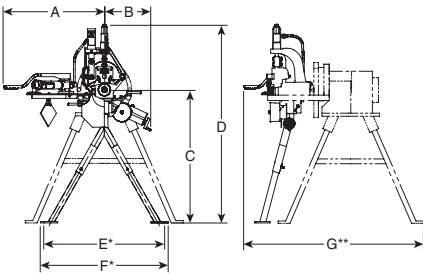

Dimensions – inches (millimeters)						
A	B	C	D	E	F	G
28.00 (711)	15.00 (381)	37.00 (940)	56.25 (1429)	34.25 (870)	27.50 (699)	61.00 (1549)

- NOTES:**
- *Mounting hole dimensions are approximate due to variables when fastening legs.
 - **Dimension is approximate due to variables when inserting into power drive.

- 2a. The required power supply (Refer to the power drive manufacturer's instructions)
- 2b. Adequate space to handle pipe/tubing lengths
- 2c. A firm and level surface for the power drive, tool, and pipe stand
- 2d. Adequate clearance around the tool for adjustment and maintenance

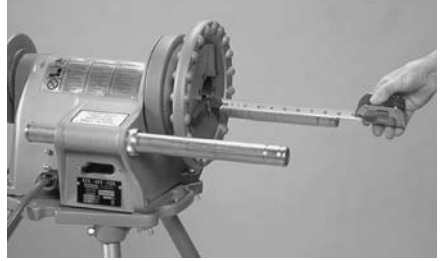

3. Remove threading dies, cutoff attachments, etc. from the power drive. Extend the two tubular support arms approximately $7\frac{1}{2}$ inches (190 mm) beyond the chuck of the power drive. Secure the support arms in this position. Refer to the power drive manufacturer's instructions.
4. Open the chuck of the power drive fully. Refer to the power drive manufacturer's instructions.

WARNING

- Support of the tool head assembly must be maintained until the support legs are installed and secured.
- Failure to support the tool head assembly may cause the tool to tip over, resulting in serious personal injury and tool damage.

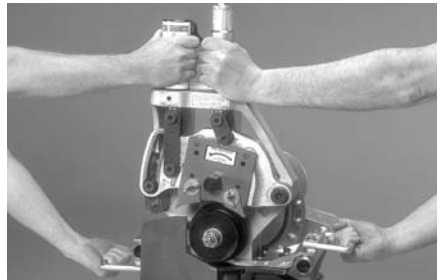

5. Slide the tool head assembly completely onto the arms of the power drive.

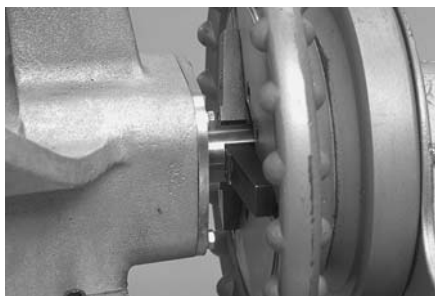

6. Allow approximately 1/2-inch (13-mm) clearance from the hex bolts on the back of the tool to the power drive chuck.

7. Align the flat portions of the drive shaft with the chuck jaws by turning the lower roll.

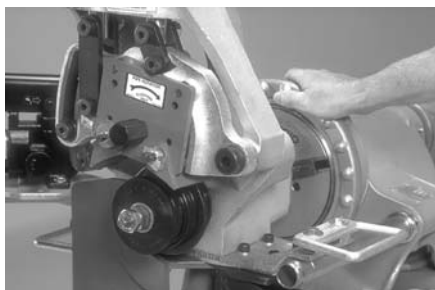

8. Tighten the chuck. Make sure the jaws engage with the flats of the drive shaft.

9. Insert the two adjustable legs completely into the sockets of the upper leg. Hand-tighten the hex bolts.



10. Insert the top of the leg assembly completely into the socket under the tool head assembly. Rotate the assembly until it seats completely in the socket. The hex head bolts on the legs should be facing toward the back of the machine (toward the power drive).



11. Tighten the hex head bolt with a wrench.



12. Loosen the hex bolts to release the two lower legs, allowing them to slide down to the floor. Turn the leg pads at the bottom until they are resting flat of the floor.



13. Level the tool from front to back. **NOTE:** The top of the hydraulic cylinder is a good location to measure "level," as shown above.



14. Using a wrench, tighten the two hex head bolts on the two legs to maintain the level position.

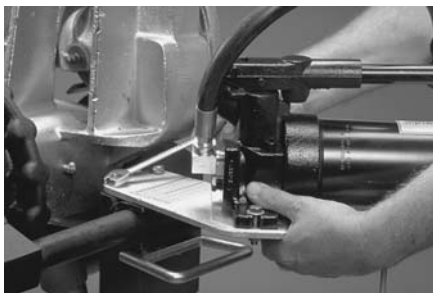

15. Attach the hand pump/pump support to the left side of the tool with the two hex bolts (supplied). Tighten the two hex bolts with a wrench.



16. Connect the hydraulic line from the hand pump to the power cylinder with the connectors provided.

17. Hang the guard setting pad on the hook provided under the base of the hand pump.

⚠ DANGER



- To reduce the risk of electric shock, check the electrical source for proper grounding and follow all instructions.
- Before performing any maintenance on the tool, turn the switch on the power drive to the "OFF" position, or disconnect the power cord from the electrical source.

Failure to follow these instructions could result in death or serious personal injury.

18. Make sure the switch on the power drive is in the "OFF" position. Plug the power drive into an internally grounded electrical outlet. The outlet must meet the requirements for the power drive (refer to the power drive manufacturer's instructions). If an extension cord is used, refer to the "Extension Cord Requirements" section on page 5 for requirements.

⚠ WARNING

- The power drive **MUST** be operated with a safety foot switch. If the power drive does not contain a safety foot switch, contact the power drive manufacturer.

Operating the tool without a safety foot switch could result in serious personal injury.



19. Turn the power drive switch to the position that will produce **CLOCKWISE** rotation of the chuck when viewed from the front of the tool. On the Victaulic VPD752 or Ridgid 300 Power Drive, placing the switch in the **REVERSE** position will produce clockwise rotation of the chuck, lower roll, and pipe/tubing.

20. Depress the safety foot switch, check the rotation of the chuck and lower roll, and make sure the tool is stable. If rotation is counter-clockwise, place the switch on the power drive to the opposite position. If the tool wobbles, make sure the tool is mounted squarely in the chuck and that the tool is level on the floor. If the wobble persists, the power drive support arms are bent or the power drive is damaged. Have the power drive repaired if the wobble persists.

21. Turn the switch on the power drive to the "OFF" position, or disconnect the power cord from the electrical source.



22. If the optional stabilizer assembly was ordered separately, attach it to the right side of the tool with the four hex bolts and four lock washers provided.

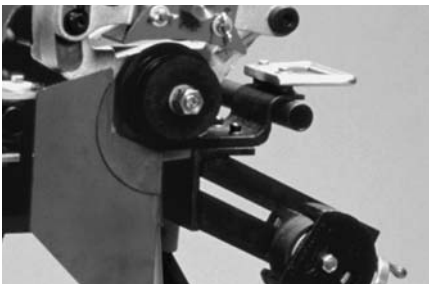

22a. Use the hex bolts provided for installing the screws.

VE272SFS TOOL SETUP IS NOW COMPLETE.

PRE-OPERATION CHECKS AND ADJUSTMENTS

Every Victaulic roll grooving tool is checked, adjusted, and tested at the factory prior to shipment. However, before attempting to operate the tool, the following checks and adjustments should be made to ensure proper tool operation.

WARNING

- Before making any tool adjustments, always turn the switch on the power drive to the "OFF" position, or disconnect the power cord from the electrical source.

Accidental startup of the tool could result in serious personal injury.

GROOVING ROLLS

Make sure the proper roll set is installed on the tool for the pipe/tubing size and material that will be grooved. Roll sets are marked with the pipe/tubing size, part number, and they are color coded for the pipe/tubing material. Refer to the "Tool Rating and Roll Selection" section, starting on page 39. If the proper rolls are not installed on the tool, refer to the "Roll Changing" section on page 23.

CAUTION

- Make sure roll-retaining bolts and nuts are tight. Loose retaining bolts and nuts could cause damage to the tool and rolls.

PIPE/TUBING PREPARATION

For proper tool operation and production of grooves that are within Victaulic specifications, the following guidelines must be followed.

1. Victaulic recommends square-cut pipe for use with grooved-end pipe/tubing products. Square-cut pipe/tubing MUST be used with FlushSeal® and EndSeal® gaskets. Beveled-end pipe/tubing may be used, provided that the wall thickness is standard wall (ANSI B36.10) or less and that the bevel meets ANSI B16.25 (37 $\frac{1}{2}$ °) or ASTM A-53 (30°). **NOTE:** Roll grooving beveled-end pipe/tubing may result in unacceptable pipe/tubing flare.

2. Raised internal and external weld beads and seams must be ground flush with the pipe/tubing surface 2 inches (50 mm) back from the pipe/tubing ends.

3. All coarse scale, dirt, and other foreign material must be removed from the interior and exterior surfaces of the pipe/tubing ends.

CAUTION

- For maximum grooving roll life, remove foreign material and loose rust from the interior and exterior surfaces of the pipe/tubing ends. Rust is an abrasive material that will wear the surface of grooving rolls.

Foreign material may interfere with or damage grooving rolls, resulting in distorted grooves and grooves that are out of Victaulic specifications.

GROOVABLE PIPE/TUBING LENGTHS

The VE272SFS is capable of grooving short pipe/tubing lengths without the use of a pipe stand. Refer to the "Short Pipe/Tubing Lengths" section on the following page.

Pipe/tubing lengths longer than those listed in Table 1 on the following page (and up to 20 feet/6 meters) must be supported with a pipe stand.

Pipe/tubing lengths from 20 feet (6 meters) up to double-random lengths (approximately 40 feet/12 meters) must be supported with two pipe stands.

SHORT PIPE/TUBING LENGTHS

 WARNING	
	Grooving rolls can crush or cut fingers and hands.
	<ul style="list-style-type: none"> Never groove pipe/tubing that is shorter than the recommended lengths listed in this manual.

Table 1 shows the minimum and maximum pipe/tubing lengths that can be grooved without the use of a pipe stand. Refer to the "Grooving Operation" section, starting on page 20, for instructions on how to groove short pipe/tubing lengths. For pipe/tubing longer than what is shown in Table 1, refer to the "Long Pipe/Tubing Lengths" section on page 13.

NOTICE
<ul style="list-style-type: none"> Grooved pipe nipples, shorter than those listed in Table 1, are available from Victaulic.

TABLE 1 – GROOVABLE PIPE/TUBING LENGTHS

Steel, Stainless Steel, Aluminum, and PVC Pipe Size		CTS US Standard Copper Tubing Size	Length – inches (mm)	
Nominal Pipe Size inches or mm	Actual Outside Diameter inches (mm)		Nominal Size inches	Minimum
3/4	1.050 26,9	–	8 205	36 915
1	1.315 33,7	–	8 205	36 915
1 1/4	1.660 42,4	–	8 205	36 915
1 1/2	1.900 48,3	–	8 205	36 915
2	2.375 60,3	2	8 205	36 915
2 1/2	2.875 73,0	2 1/2	8 205	36 915
3	3.500 88,9	3	8 205	36 915
3 1/2	4.000 101,6	–	8 205	36 915
4	4.500 114,3	4	8 205	36 915
4 1/2	5.000 127,0	–	8 205	32 815
5	5.563 141,3	5	8 205	32 815
152,4 mm	6.000 152,4	–	10 255	30 765
6	6.625 168,3	6	10 255	28 715
203,2 mm	8.000 203,2	–	10 255	24 610
8	8.625 219,1	8	10 255	24 610
10	10.750 273,0	–	10 255	20 510
12	12.750 323,9	–	12 305	18 460

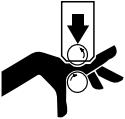
Nominal Size millimeters		Length - millimeters	
European Standard Copper Tubing Size	Australian Standard Copper Tubing Size	Minimum	Maximum
54	DN50	205	915
64	DN65	205	915
66,7		205	915
76,1	DN80	205	915
88,9		205	915
108	DN100	205	915
133	DN125	205	815
159	DN150	255	715

If pipe/tubing is required that is shorter than the minimum length listed in Table 1, shorten the next-to-last piece so that the last piece is as long (or longer) than the minimum length specified. Refer to the example below.

EXAMPLE: A 20-foot, 4-inch (6,2-m) length of 10-inch diameter steel pipe is required to finish a section, and only 20-foot (6,1-m) lengths are available. Instead of roll grooving a 20-foot (6,1-m) length of steel pipe and a 4-inch (0,1-m) length of steel pipe, follow these steps:

1. Refer to Table 1 on this and the previous page, and note that for 10-inch diameter steel pipe, the minimum length that should be roll grooved is 10 inches (255 mm).
2. Roll groove a 19-foot, 6-inch (5,9-m) length of pipe and a 10-inch (255-mm) length of pipe. Refer to the "Long Pipe/Tubing Lengths" section on page 13.

LONG PIPE/TUBING LENGTHS

When roll grooving pipe/tubing that exceeds the maximum length shown in Table 1, a roller-type pipe stand must be used. The roller-type pipe stand must be capable of handling the weight of the pipe/tubing, while allowing the pipe/tubing to rotate freely.

1. Make sure the tool is level. Refer to the "Tool Setup" section on page 7 for leveling requirements.
2. When pipe/tubing flare is excessive, right-to-left tracking must be kept to a minimum. It may be necessary to use less than $1/2^\circ$ for the tracking angle.

3. Installation of couplings on pipe/tubing that exceeds the maximum allowable flare may prevent pad-to-pad closure of the housings and/or may cause damage to the coupling gasket. Refer to the applicable "Roll Groove Specifications" table for details.

4. If the tool is properly set up in a level position, but the back end of the pipe/tubing is higher than the end being grooved, the pipe/tubing may not track. As a result, excessive flare may occur on the pipe/tubing end. Refer to the "Tool Setup" section, starting on page 7, and Figures 1 and 2 below for tool setup and pipe positioning requirements.

NOTICE

- Figure 1 shows the Victaulic Adjustable Pipe Stand (VAPS 112). The VAPS 112 is suitable for $3/4$ - 12-inch sizes. The Victaulic Model VAPS 224 is suitable for 2 - 24-inch sizes. Refer to the "Accessories" section on page 35.
- For additional information about pipe stands, refer to the instructions included with the pipe stand.

5. Place the pipe stand at a distance slightly beyond half the pipe/tubing length from the tool. Refer to Figure 1 below.

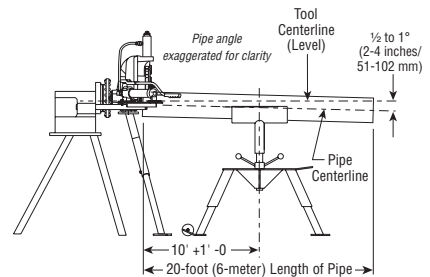

Figure 1 - Support of Pipe

6. Position the pipe stand approximately $1/2^\circ$ to the left for the tracking angle. Refer to Figure 2 below.

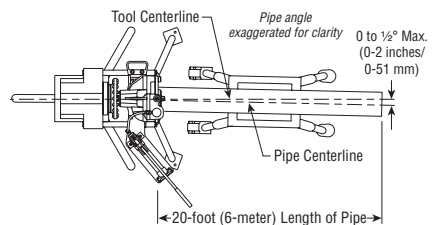

Figure 2 - Tracking Angle

ROLL GUARD ADJUSTMENT

WARNING

- Before making any tool adjustments, always turn the switch on the power drive to the "OFF" position, or disconnect the power cord from the electrical source.

Accidental startup of the tool could result in serious personal injury.

VE272SFS guards must be adjusted every time rolls are changed or when the pipe/tubing size or wall thickness is different from pipe/tubing that was grooved previously.

1. Make sure the proper roll set is installed on the tool for the pipe/tubing size and material that will be grooved. Roll sets are marked with the pipe/tubing size/part number, and they are color-coded for the pipe material. Refer to the "Tool Rating and Roll Selection" section, starting on page 39. If the proper rolls are not installed on the tool, refer to the "Roll Changing" section on page 23.

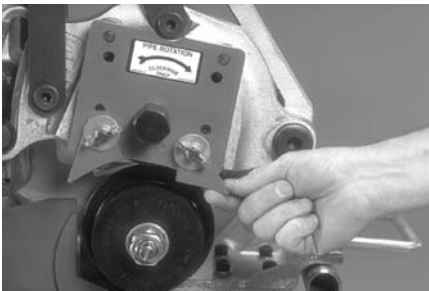

2. Loosen the wing nuts, and move the roll guards to the full-up position. Tighten the wing nuts.



3. Set the groove diameter stop to the pipe/tubing size and schedule/thickness that will

be grooved. To set the groove diameter stop, back off the depth adjuster lock, align the depth adjuster with the proper diameter and thickness, and lock the setting in position with the depth adjuster lock.



4. If the tool is equipped with a stabilizer, retract the stabilizer, if necessary, to insert the pipe. To retract the stabilizer, loosen the stabilizer locking handle, and retract the stabilizer roller with the hand wheel to provide clearance for the pipe when it is inserted onto the lower roll.

WARNING

Grooving rolls can crush or cut fingers and hands.

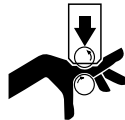

- Loading and unloading pipe/tubing will place your hands close to the rollers. Make sure your hands are away from the rollers when the machine is running.
- Never groove pipe/tubing that is shorter than the recommended lengths listed in this manual.



5. Insert a length of pipe/tubing of the correct size and schedule/ thickness over the lower roll with the pipe/tubing end against the lower roll backstop flange. Refer to the "Pipe/ Tubing Preparation" section on page 11.



6. Close the hand pump valve by turning the knob **clockwise**.

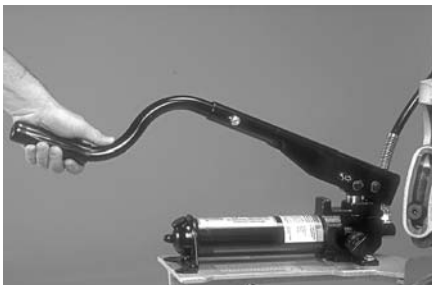

7. Using the hand pump, bring the upper roll down into firm contact with the pipe/tubing.



9. Loosen the wing nuts, and adjust each guard to conform to and lightly pinch the guard-setting pad against the pipe/tubing. Tighten the wing nuts to secure the guards into position.

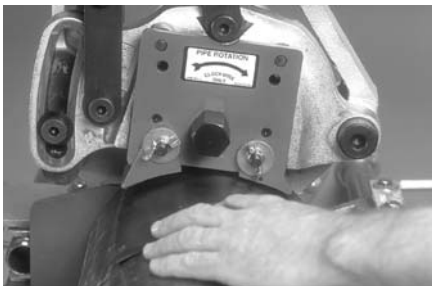

8. Remove the guard-setting pad from its storage hook beneath the pump support. Hold the guard-setting pad firmly against the pipe/tubing, and push it under the roll guards until it is flush against the red plate.

10. Remove the guard-setting pad. Store the pad back on the hook provided under the pump support.

PIPE STABILIZER ADJUSTMENT

(Applies only to tools equipped with the optional pipe stabilizer)

The optional pipe stabilizer for the VE272SFS is designed to prevent pipe sway for 8 – 12-inch NPS sizes in short and long lengths. When the stabilizer is adjusted for a selected pipe size and wall thickness, it does not require further adjustment unless pipe of a different size and wall thickness will be grooved. Pipe of the same size and thickness may be moved in and out of the tool without retracting the stabilizer.

WARNING

- Before making any tool adjustments, always turn the switch on the power drive to the "OFF" position, or disconnect the power cord from the electrical source.

Accidental startup of the tool could result in serious personal injury.

1. Make sure the proper roll set is installed on the tool for the pipe size and material to be grooved. Rolls are marked with the pipe size, part number, and they are color-coded according to the pipe material. Refer to the "Tool Rating and Roll Selection" section, starting on page 39.



2. Loosen the stabilizer locking handle. Using the hand wheel, retract the stabilizer roller to clear the pipe when it is inserted onto the lower roll.

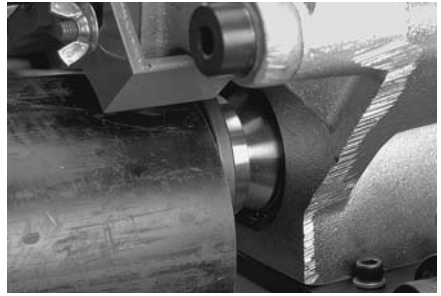

3. Insert a length of pipe that is the correct size and schedule over the lower roll. Make sure the pipe end contacts the lower-roll backstop flange.



4. Close the hand pump valve by turning the knob **clockwise**.

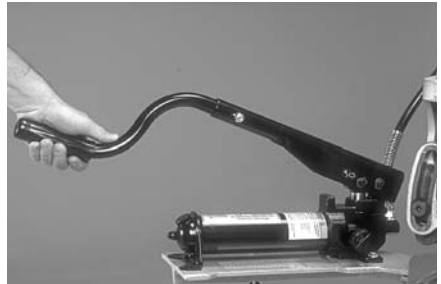

5. Using the hand pump, bring the upper roll down into firm contact with the pipe.

6. Make sure the guards are adjusted properly. Refer to the "Roll Guard Adjustment" section on page 14.

! CAUTION

- **DO NOT** adjust the stabilizer to push the pipe to the left and off center from the rolls. Increased pipe-end flare and shortened roll life will result if the pipe is pushed to the left and off center.
- Assembly of couplings on pipe that exceeds the maximum allowable flare dimension may prevent proper pad-to-pad assembly of coupling housings and may cause gasket distortion/damage.

Failure to prepare pipe in accordance with all instructions may cause joint failure, resulting in personal injury and/or property damage.



7. Using the hand wheel, advance the stabilizer roller inward until the roller lightly contacts the pipe. Tighten the stabilizer locking handle. Refer to Figures 3 and 4 on this page for proper positioning.

8. Complete all adjustments and groove the pipe. Refer to the "Grooving Operation" section, starting on page 20. Observe the stabilizer roller while grooving. It should remain in contact with the pipe, and the pipe should rotate smoothly without swaying from side to side. If the pipe is not rotating smoothly or is swaying from side to side, adjust the stabilizer roller further inward. Continue the grooving operation and make further adjustments, as necessary. **DO NOT** adjust the stabilizer too far inward, since it will skew the pipe to the left and off center, resulting in excessive pipe-end flare.

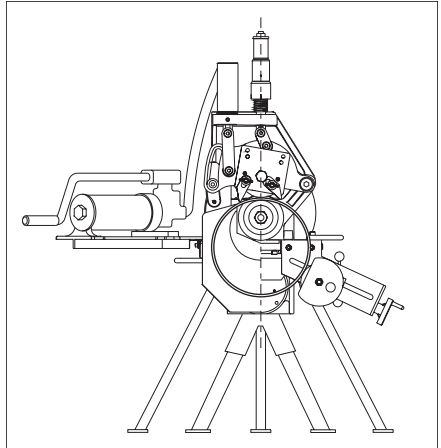

Figure 3 - "CORRECT"

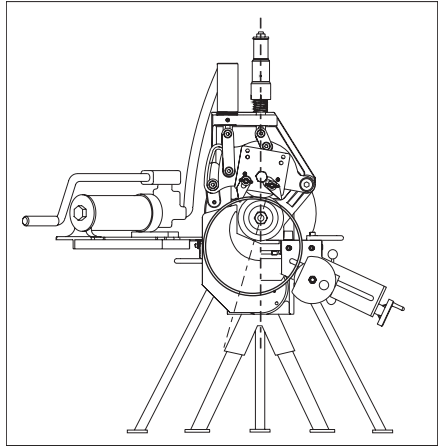

Figure 4 - "INCORRECT"

GROOVE DIAMETER STOP ADJUSTMENT

The groove diameter stop must be adjusted for each pipe/tubing size or change in wall thickness. The groove diameter, which is identified as the "C" dimension, is listed under the "Roll Groove Specifications" section, starting on page 45. In addition, a label is affixed to the tool, which lists the "C" dimensions.

NOTICE

- To perform the following adjustments, use several short, scrap sections of pipe/tubing that are the proper material, diameter, and thickness to be grooved. Make sure the scrap sections meet the length requirements listed in Table 1 on page 12.

To achieve the proper diameter:

- a. Determine the diameter and thickness of the pipe/tubing to be grooved.
- b. Locate the proper pipe diameter and thickness on the pipe/tubing-size indicator label of the depth stop. The depth stop can be rotated for easy viewing.



1. Back off the depth adjuster lock. Align the top edge of the depth adjuster with the line down and to the right of the proper size and schedule markings, as shown above. Lock the depth adjuster in position with the depth adjuster lock.

NOTICE

- The markings provide an approximate groove diameter adjustment and are not exact groove diameter settings. Variations in pipe/tubing OD and wall thickness make it impossible to calibrate the groove diameter stop exactly.

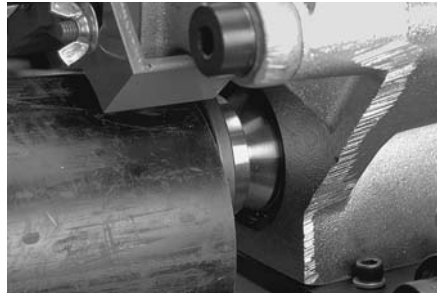

2. Insert a length of pipe/tubing over the lower roll with the pipe/tubing end against the lower-roll backstop flange.

WARNING

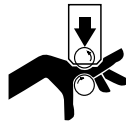

Grooving rolls can crush or cut fingers and hands.

- Before making any tool adjustments, always turn the switch on the power drive to the "OFF" position, or disconnect the power cord from the electrical source.
 - Make sure the guard is adjusted properly before grooving pipe/tubing.
 - Loading and unloading pipe/tubing will place your hands close to the rollers. Keep hands away from the grooving rolls and stabilizer wheel during operation.
 - Never reach inside pipe/tubing end or across the tool or pipe/tubing during operation.
 - Always groove pipe/tubing in a CLOCKWISE direction only.
 - Never groove pipe/tubing that is shorter than the recommended lengths listed in this manual.
 - Never wear loose clothing, loose gloves, or anything that can become entangled in moving parts
3. Prepare a trial groove. Refer to the "Grooving Operation" section, starting on page 20.



4. After a trial groove is prepared and the pipe/tubing is removed from the tool, carefully check the groove diameter ("C" dimension). Refer to the "Roll Groove Specifications" section, starting on page 45. The PT-100 Pipe Tape, supplied with the tool, is the best method for checking the "C" dimension. In addition, a vernier caliper or narrow-land micrometer can be used to check this dimension at two locations (90° apart) around the groove. The average reading must be within the required groove diameter specification.

! CAUTION

- The "C" dimension (groove diameter) must conform to Victaulic specifications to ensure proper joint performance.

Failure to follow this instruction could cause joint failure, resulting in personal injury and/or property damage.

5. If the groove diameter ("C" dimension) is not within Victaulic specifications, the diameter stop must be adjusted.

5a. To adjust for a smaller groove diameter, turn the depth adjuster **counterclockwise** (when viewed from above the tool).

5b. To adjust for a larger groove diameter, turn the depth adjuster **clockwise** (when viewed from above the tool).

NOTE: A quarter-turn either way will change the groove diameter adjustment by approximately 0.031 inch (0,8 mm) or 0.125 inch (3,2 mm) per full turn.

6. Prepare another trial groove, and check the groove diameter ("C" dimension), as described in step 4. Repeat these steps, as necessary, until the groove diameter is within specification.

GROOVING OPERATION

⚠ DANGER



- To reduce the risk of electric shock, check the electrical source for proper grounding and follow all instructions.
- Before operating the tool, review the "Operator Safety Instructions" section on page 3 of this manual.

Failure to follow these instructions could result in death or serious personal injury.

⚠ CAUTION

- This tool must be used **ONLY** for roll grooving pipe/tubing designated in the "Tool Rating and Roll Selection" section of this manual.

Failure to follow this instruction could overload the tool, resulting in reduced tool life and/or damage to the tool.

1. Before grooving, make sure all instructions in the previous sections of this manual have been followed.
2. Plug the power drive into an internally grounded electrical source. **NOTE:** The power drive **MUST** be grounded. Refer to the power drive manufacturer's instructions for detailed information.



3. Set the power drive switch to produce **CLOCKWISE** rotation of the lower roll and pipe/tubing when viewed from the front of the tool. On the Victaulic VPD752 Power Drive and Ridgid 300 Power Drive, place the switch in the reverse position to produce clockwise rotation of the lower roll and pipe/tubing.

⚠ WARNING

- The power drive **MUST** be operated with a safety foot switch. If the power drive does not contain a safety foot switch, contact the power drive manufacturer.
- Operating the tool without a safety foot switch could result in serious personal injury.

4. Make sure the tool is operational by depressing the safety foot-switch pedal. The lower roll must turn **CLOCKWISE** when viewed from the front of the tool. Remove foot from the safety foot switch.



5. Open the hand pump valve by turning the knob **counterclockwise**. Opening the hand pump valve will allow the upper roll and arm to move to the full up position.

⚠ WARNING

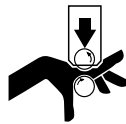

Grooving rolls can crush or cut fingers and hands.

- Before making any tool adjustments, always turn the switch on the power drive to the "OFF" position, or disconnect the power cord from the electrical source.
- Make sure the roll guards are adjusted properly before grooving pipe/tubing.
- Loading and unloading pipe/tubing will place your hands close to the rollers. Keep hands away from the grooving rolls and stabilizer wheel during operation.
- Never reach inside pipe/tubing end or across the pipe/tubing during operation.
- Always groove pipe/tubing in a **CLOCKWISE** direction only.
- Never groove pipe/tubing that is shorter than the recommended lengths listed in this manual.
- Never wear loose clothing, loose gloves, or anything else than can become entangled in moving parts

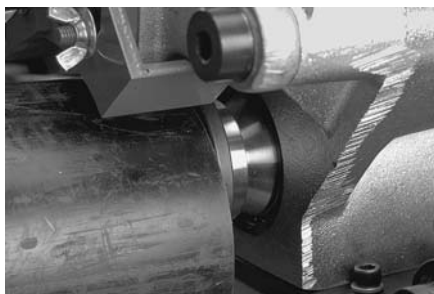

6. Insert a length of pipe/tubing that is the correct size and thickness onto the lower roll. Make sure the pipe/tubing end contacts the lower-roll backstop flange completely. If the pipe/tubing is being supported with a pipe stand, remove hands from the pipe/tubing.



7. Close the hand pump valve by turning the knob **clockwise**.

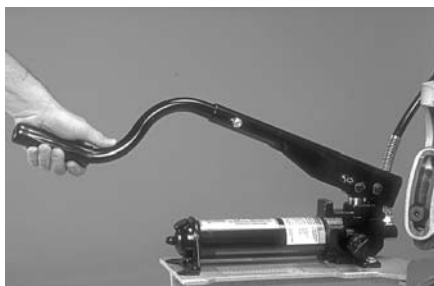

8. Use the hand pump to bring the upper roll down into firm contact with the pipe/tubing.

8a. If grooving a short length of pipe/tubing (refer to Table 1 on page 12 for requirements), remove hands from the pipe/tubing.

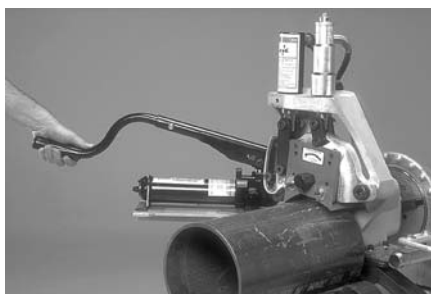

9. Depress and hold down the safety foot-switch pedal. The pipe/tubing will begin to rotate clockwise. As the pipe/tubing rotates, begin the grooving process by slowly pumping the handle of the hand pump.

NOTICE

- **DO NOT** pump the handle too fast. The rate should be sufficient to groove the pipe/tubing and maintain an audible, moderate-to-heavy load on the power drive motor.



10. Continue the grooving process until the depth stop makes firm contact with the top of the tool body. Continue to rotate the pipe/tubing for one to three revolutions to ensure groove completion.

11. Release the safety foot switch pedal, and withdraw foot from the safety foot switch.

! WARNING

- **DO NOT** place hands inside the pipe/tubing end or in the area of the grooving rolls or stabilizer roller while the pipe/tubing is still rotating. Failure to follow these instructions could result in serious personal injury.

11a. If a short length of pipe/tubing is in the tool, manually support the pipe/tubing.



12. To release the pipe/tubing, open the hand pump valve by turning the knob **counterclockwise**. Remove the pipe/tubing from the tool.

NOTICE

- The groove diameter must be within specification for the diameter and wall thickness of pipe/tubing. The groove diameter should be checked and adjusted, as necessary, to ensure grooves remain within specification.

ROLL CHANGING



WARNING

- **Before changing rolls, always turn the switch on the power drive to the "OFF" position, or disconnect the power cord from the electrical source.**

Accidental startup of the tool could result in serious personal injury.

The VE272SFS roll grooving tool is designed with rolls to accommodate several pipe/tubing sizes, which eliminates the need for frequent roll changes.

An upper roll and a "Keyless" lower roll for 8 – 12-inch steel pipe are factory installed on the tool. When 2 – 6-inch steel pipe or other pipe materials are required for grooving, the upper and lower rolls must be changed. Refer to the following sections:

1. "Upper Roll Removal" section on page 25
2. "Lower Roll Removal for 2-inch and Larger Sizes" section on page 24
3. "Lower Roll Installation for 2-inch and Larger Sizes" section on page 30
4. "Upper Roll Installation" section on page 28

When 1½-inch and smaller size steel pipe is required for grooving, the optional lower roll/adapter assembly for ¾-inch and 1 – 1½-inch steel pipe must be ordered and installed. In addition, the correct upper roll for steel pipe must be installed. To accomplish this, the upper and lower rolls and the arbor for 2-inch and larger sizes must be removed. Refer to the following sections:

1. "Upper Roll Removal" section on page 25
2. "Lower Roll Removal for 2-inch and Larger Sizes" section on page 24
3. "Arbor Removal" section on page 26
4. "Lower Roll/Adapter Assembly Installation" section on page 27

5. "Upper Roll Installation" section on page 28

In addition, different pipe materials may require different rolls. For proper roll selection, refer to the "Tool Rating and Roll Selection" section, starting on page 39.

LOWER ROLL REMOVAL

for 2-inch and Larger Sizes



1. Open the hand pump valve by turning the knob **counterclockwise**. Opening the hand pump valve will allow the upper roll and arm to move to the full up position.

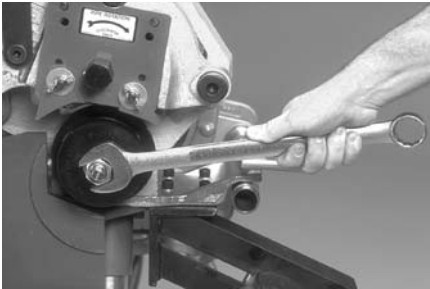

2. Using a wrench, loosen (**counterclockwise**) and remove the thin jam nut that secures the thicker nut onto the threaded stud of the arbor.

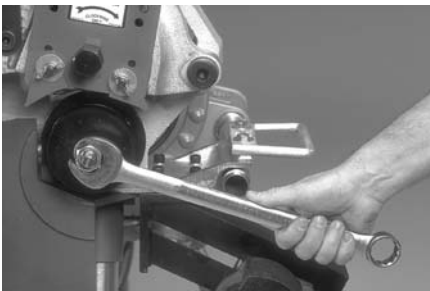

3. Using a wrench, loosen (**counterclockwise**) the thicker nut on the threaded stud of the arbor. Back off the nut approximately $\frac{1}{4}$ inch (6 mm) without removing it from the threaded stud of the arbor.

WARNING



DO NOT strike the roll with a hammer or other blunt object. Striking the roll can cause fragmentation, resulting in serious personal injury.

- Always wear safety glasses.

- Use only the supplied aluminum wedge for roll removal.
- Use only soft-faced hammers with the aluminum wedge.
- Never strike the roll directly for any reason.

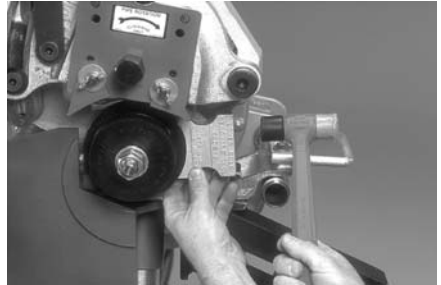

4. To loosen the lower roll from the arbor, use the aluminum wedge supplied with the tool. Place the aluminum wedge behind the lower roll, and strike the wedge with a soft-faced hammer to break the roll loose from the arbor. **DO NOT STRIKE THE ROLL DIRECTLY WITH A HAMMER.**

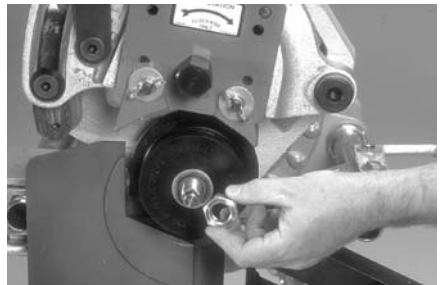

5. Remove the thick nut, washer, and lower roll. Store these items in a clean, dry location.

UPPER ROLL REMOVAL

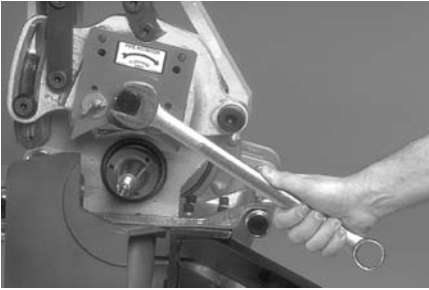

1. Using a wrench, loosen (**counterclockwise**) and remove the bolt from the upper roll. Store the bolt in a clean, dry location.

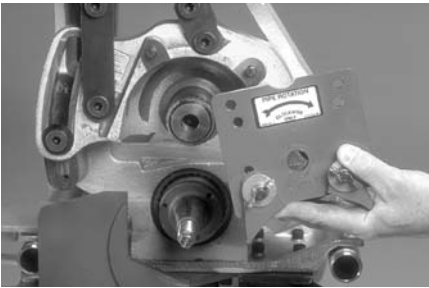

2. Remove the upper roll assembly. Store the upper roll in a clean, dry location.

ARBOR REMOVAL

This procedure is necessary for grooving smaller-size pipe or for replacing a damaged arbor. The standard arbor installed in the tool is specifically for 2 – 12-inch pipe. When it is necessary to groove 1½-inch and smaller size pipe, the optional lower roll/adaptor assembly must be ordered and installed.

1. Refer to the "Lower Roll Removal for 2-inch and Larger Sizes" section, starting on page 24, to remove the lower roll.

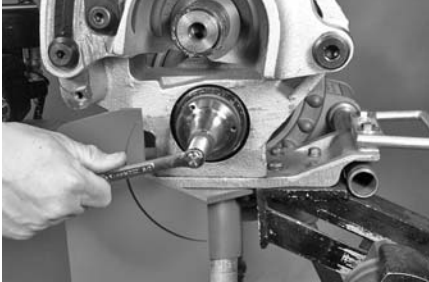

2. With a wrench engaged on the exposed hex-portion stud of the arbor, loosen the arbor by turning **counterclockwise**. **NOTE:** The arbor should move outward as it is being loosened.



3. When the arbor has stopped moving outward, pull the arbor out of the tool. Store the arbor in a clean, dry location.

CAUTION

- **NEVER** operate the tool with jack bolts installed in the arbor.
Failure to follow this instruction will result in improper tool operation and tool damage.

NOTICE

- If the arbor was insufficiently lubricated, it may be difficult to remove it from the drive shaft.
- The arbor features three ¼ - 20 UNC tapped holes so that jack bolts (not supplied) can be used to push the arbor out of the tool.

LOWER ROLL/ADAPTER ASSEMBLY INSTALLATION

for $\frac{3}{4}$ -inch and 1 – $1\frac{1}{2}$ -inch Sizes

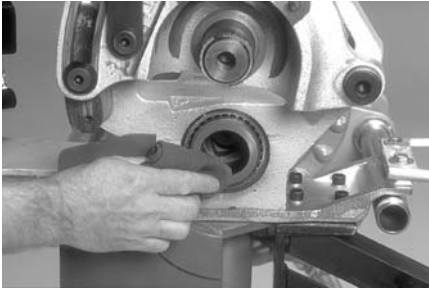

1. Using a soft cloth, clean the bore of the main shaft and the lower roll/adapter assembly.



2. Lightly lubricate the lower roll/adapter assembly with dry graphite spray (supplied with the tool and available from the Victaulic Tool Company).

NOTICE

- The $\frac{3}{4}$ -inch and 1 – $1\frac{1}{2}$ -inch lower roll/adapter assembly is held in position with left-hand threads and must be tightened by turning COUNTERCLOCKWISE.



3. Carefully insert the lower roll/adapter assembly into the main shaft. Make sure the lower roll/adapter assembly is fully seated on the main shaft. It may be necessary to rotate the lower roll/adapter assembly to align its square end with the square bore in the main shaft. Tighten the lower roll/adapter assembly by turning **counterclockwise**.

UPPER ROLL INSTALLATION

Refer to the "Tool Rating and Roll Selection" section, starting on page 39, for information regarding grooving rolls.



1. Before installing the upper roll, clean any dirt and scale from all shaft surfaces and roll bores.

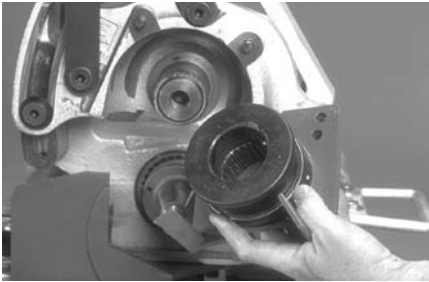

2. While the upper roll is removed from the tool, inspect the internal roller bearing for contamination, proper lubrication, and freedom of movement. In addition, inspect the guards for wear and freedom of movement. Repair or replace damaged components, as necessary.

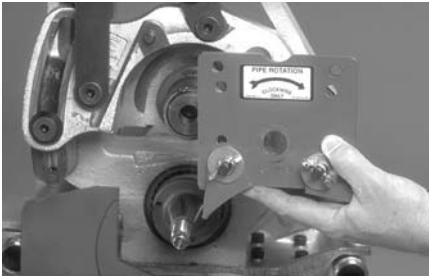

3. Carefully slide the desired upper roll assembly onto the upper shaft with the red plate facing out. Loosen the guards, if necessary, to ease installation. Make sure the red plate engages the two pins on the arm and that it contacts the front of the upper roll shaft.

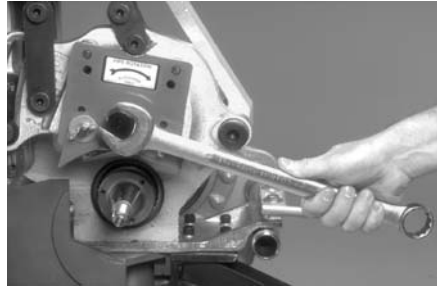

4. Insert the bolt for the upper roll. Tighten the bolt (**clockwise**) securely with a wrench.

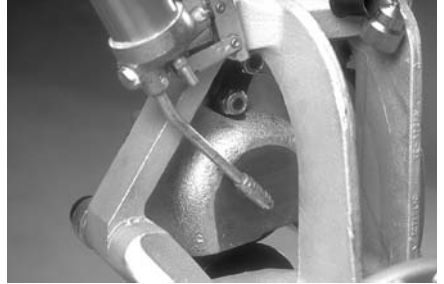

5. Lubricate the upper roll bearing. Refer to the "Maintenance" section, starting on page 32, for additional maintenance information.

LOWER ROLL/ADAPTER ASSEMBLY REMOVAL

for $\frac{3}{4}$ -inch and 1 – $1\frac{1}{2}$ -inch Sizes



1. Open the hand pump valve by turning the knob **counterclockwise**. Opening the hand pump valve will allow the upper roll and arm to move to the full up position.

NOTICE

- The $\frac{3}{4}$ -inch and 1 – $1\frac{1}{2}$ -inch lower roll/adapter assembly is held in position with left-hand threads and must be removed by turning **CLOCKWISE**.



2. With a wrench engaged on the square end of the lower roll/adapter assembly, remove the lower roll/adapter assembly by turning clockwise. Store the lower roll/adapter assembly in a clean, dry location.

ARBOR INSTALLATION

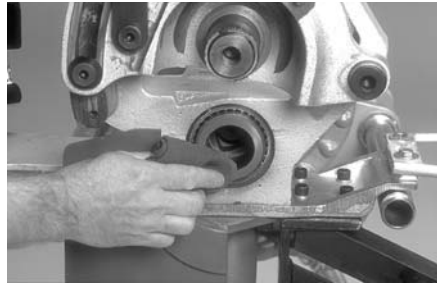

1. Using a soft cloth, clean the bore of the main shaft and the arbor.



2. Lightly lubricate the arbor with dry graphite spray (supplied with the tool and available from the Victaulic Tool Company).



3. Carefully insert the arbor into the main shaft. Make sure the arbor is fully seated in the main shaft. It may be necessary to rotate the arbor to align its square end with the square bore in the main shaft. Tighten the arbor into the main shaft by turning the exposed hex-portion of the threaded stud **clockwise**.

4. Install the lower roll for the correct size and pipe material by referring to the "Lower Roll Installation" section on page 30.

- 4a. Make sure the upper roll is installed for the correct pipe size and material.

LOWER ROLL INSTALLATION

for 2-inch and Larger Sizes

NOTICE

- The arbor must be installed before attempting to install the lower roll. Refer to the "Arbor Installation" section on page 29.

⚠ CAUTION

- Make sure the square drive flats of the roll are aligned properly with the square drive flats of the arbor.
- Make sure the thick nut is tightened securely onto the threaded stud of the arbor.

Failure to follow these instructions can result in the lower roll slipping on the arbor and causing damage to the arbor.

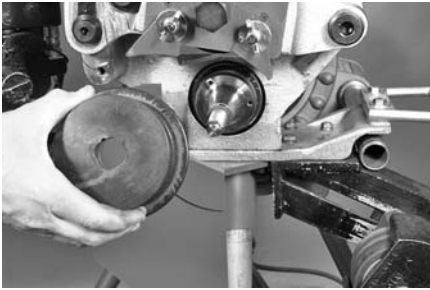

1. Place the lower roll onto the arbor. Reposition the roll guards, if necessary, to ease assembly. Make sure the lower roll fits fully onto the arbor. **NOTE:** The square drive flats of the roll must be aligned with the square drive flats of the arbor.



2. Install the flat washer and thick nut onto the threaded stud of the arbor in front of the lower roll. Tighten the thick nut **clockwise** securely with a wrench.

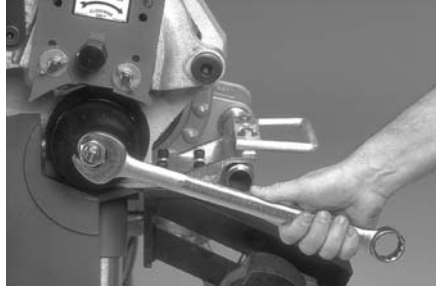

3. Install the thin jam nut onto the threaded stud of the arbor. Using a wrench, tighten the thin jam nut **clockwise** securely against the thick nut.



4. Close the hand pump valve by turning the knob **clockwise**.

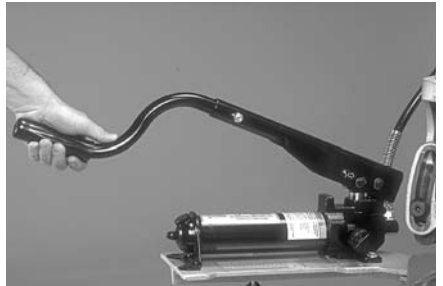

5. Pump the hand pump several times until the upper roll interlocks with the lower roll. This will confirm proper roll installation.



6. Open the hand pump valve by turning the knob **counterclockwise**.

7. Lower roll installation for 2-inch and larger sizes is now complete. Before grooving, follow all steps in the "Pre-Operation Checks and Adjustments" section on page 11.

MAINTENANCE

⚠ DANGER



- Before performing any maintenance on the tool, turn the switch on the power drive to the “OFF” position, or disconnect the power cord from the electrical source.

Failure to follow these instructions could result in death or serious personal injury.

This section provides information about keeping tools in proper operating condition and guidance for making repairs, when necessary. Preventive maintenance during operation will pay for itself in repair and operating savings.

Replacement parts must be ordered from Victaulic Tool Company to ensure proper and safe operation of the tool.

LUBRICATION

- 1.** After every 8 hours of operation, lubricate the machine. Always lubricate the upper roll bearings when rolls are changed.

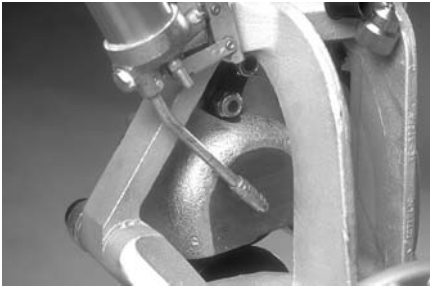

- 2.** Grease the upper roll bearing at the grease fitting with a No. 2EP lithium-base grease, as shown above.

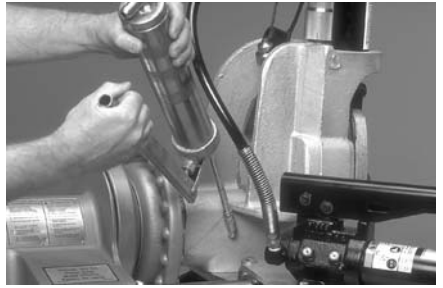

- 3.** Grease the main shaft bearings at the grease fitting with a No. 2EP lithium-base grease, as shown above.

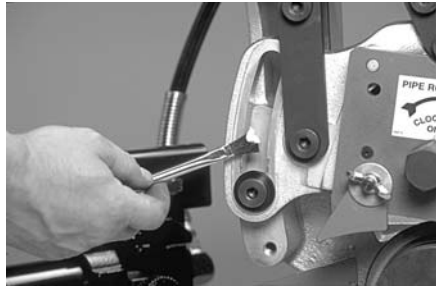

- 4.** Lubricate the linkage mechanisms, the arm pivot point, and the arm sliding surfaces with a heavy-duty spray lubricant, or grease may be applied by hand.

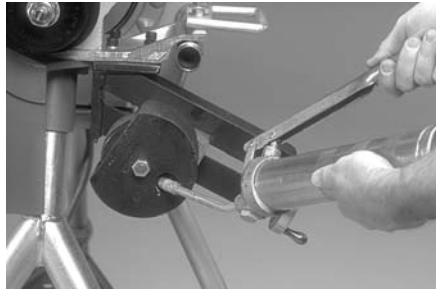

- 5. For tools equipped with the optional pipe stabilizer:** Lubricate the stabilizer wheel with a No. 2EP lithium-base grease, as shown above.

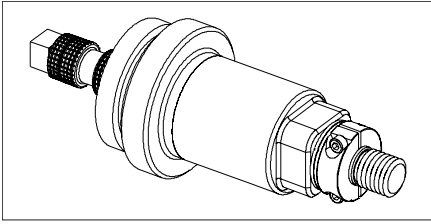

6. After every 40 hours of operation, clean and lubricate the $\frac{3}{4}$ -inch lower roll (if equipped) and the 1 – $1\frac{1}{2}$ -inch lower roll.

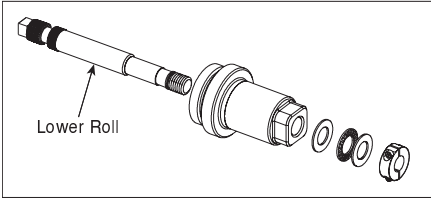

7. Remove the cap screws, and disassemble the two-piece collar. Remove both the collar and the needle bearing, along with the washers.

8. Remove the lower roll from the arbor. Clean the $\frac{3}{4}$ -inch lower roll (if equipped) and the 1 – $1\frac{1}{2}$ -inch lower roll. Lightly lubricate the lower rolls with dry graphite spray (supplied with the tool and available from the Victaulic Tool Company).

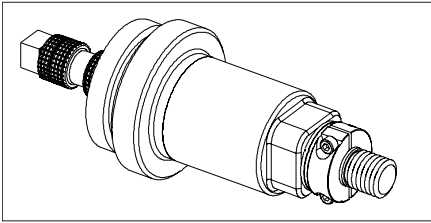

9. Re-assemble the $\frac{3}{4}$ -inch lower roll (if equipped) and the 1 – $1\frac{1}{2}$ -inch lower roll. Lubricate the needle bearing with bearing grease. Make sure the end gaps are uniform on the two-piece collar.

CHECKING AND FILLING HYDRAULIC SYSTEMS

The hydraulic fluid level in the hand pump must be checked semi-annually or if the pump feels “spongy.”



1. Open the hand pump valve by turning the knob **counterclockwise**.

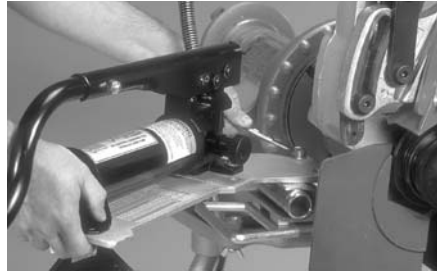

2. Remove the hand pump/pump support from the tool base.



3. Loosen, but do not remove, the hydraulic fill plug/dipstick at the back end of the pump.



4. Hold the hand pump so that the fill plug end is **ABOVE** the hydraulic cylinder. This will prevent siphoning of oil from the hydraulic cylinder through the hand pump.

5. Check the fluid level. Add hydraulic jack oil (ISO 32) to the proper level, as required. On models without a dipstick, remove the cap. Oil should be approximately $\frac{1}{2}$ - 1 inch (13 - 25 mm) from the end.

AIR BLEEDING



1. To bleed air from the system, hold the entire hand pump above the hydraulic cylinder. Close the hand pump valve by turning the knob **clockwise**. Open the fill plug one full turn.

2. Pump the hand pump several times to build pressure.

3. Open the hand pump valve by turning the knob **counterclockwise**, and allow air to escape.

4. Repeat steps 1 - 3 several times to bleed all air from the system.

5. Check the oil level. Add more oil, if necessary.

6. Continue to hold the pump above the hydraulic cylinder, and close the fill plug.

7. Install the hand pump/pump support securely to the tool by following steps 15 - 17 of the "Tool Setup" section on page 9.

PARTS ORDERING INFORMATION

When ordering parts, the following information is required for the Victaulic Tool Company to process the order and send the correct part(s). Request the RP-272SFS Repair Parts List for detailed drawings and parts listings.

1. Tool Model Number – VE272SFS
2. Tool Serial Number – The serial number is stamped onto the tool body
3. Quantity, Part Number, and Description – For example, (1), R029266MCH, Main Shaft
4. Where to Send the Part(s) – Company name and address
5. To Whose Attention to Send the Part(s)
6. Purchase Order Number

Order parts from the Victaulic Tool Company at the address listed in this manual.

ACCESSORIES

VAPS 112 VICTAULIC ADJUSTABLE PIPE STAND



The Victaulic VAPS 112 is a portable, adjustable, roller-type pipe stand that contains four legs for additional stability. Ball transfer rollers, adjustable for $\frac{3}{4}$ - 12-inch pipe, accommodate linear and rotational movement. The turnstile design permits ease of grooving for both pipe ends. Contact Victaulic Tool Company for details.

VAPS 224 VICTAULIC ADJUSTABLE PIPE STAND



The Victaulic VAPS 224 contains features that are similar to the VAPS 112, but it is suitable for 2 – 24-inch pipe sizes. Contact the Victaulic Tool Company for details.

VPD752 POWER DRIVE



The Victaulic VPD752 Power Drive can be used as the power drive unit for several different roll grooving tool models with the correct base plate. The power drive utilizes a 60 Hz universal motor and requires 115V/1 Phase, 15 amps of power. A safety foot switch is included for proper operation. Contact the Victaulic Tool Company for details.

STABILIZER ASSEMBLY

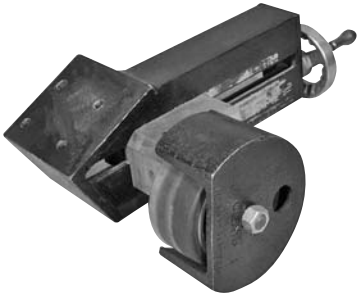

A pipe stabilizer is available to prevent pipe sway on 8 – 12-inch pipe sizes. Contact the Victaulic Tool Company for details.

OPTIONAL ROLLS

Refer to the "Tool Rating and Roll Selection" section, starting on page 39, for rolls that are available for different materials and groove specifications.

TROUBLESHOOTING

Problem	Possible Cause	Solution
Pipe/tubing will not stay in grooving rolls.	<p>Incorrect pipe/tubing positioning of long pipe/tubing length.</p> <p>Lower roll and pipe/tubing are not rotating clockwise.</p>	<p>Refer to the "Long Pipe/Tubing Lengths" section on page 13.</p> <p>Flip the switch on the power drive to the opposite rotation position.</p>
Pipe/tubing stops rotating during grooving.	<p>Rust or dirt buildup is present on the lower roll.</p> <p>Rust or dirt is excessively heavy inside the pipe/tubing end.</p> <p>Worn grooving rolls.</p> <p>Power drive has stalled due to excessive pumping of the hand pump.</p> <p>The circuit breaker has tripped or a fuse has blown out on the electrical circuit that supplies the power drive.</p>	<p>Remove rust or dirt accumulation from the lower roll with a stiff wire brush.</p> <p>Remove heavy rust and dirt from inside the pipe/tubing end.</p> <p>Inspect the lower roll for worn knurls. Replace the lower roll if excessive wear is present.</p> <p>Support the pipe/tubing. Open the hand pump valve by turning the knob counterclockwise. Close the hand pump valve by turning the knob clockwise. Continue grooving by pumping the hand pump at a moderate rate.</p> <p>Reset the breaker, or replace the fuse.</p>
While grooving, loud squeaks echo through the pipe/tubing.	<p>Incorrect pipe/tubing support positioning of long pipe/tubing. Pipe/tubing is "over-tracking."</p> <p>Pipe/tubing end is not cut square.</p> <p>Pipe/tubing is rubbing excessively on the lower roll backstop flange.</p>	<p>Move the pipe/tubing support to the right. Refer to the "Long Pipe/Tubing Lengths" section on page 13.</p> <p>Cut the pipe/tubing end squarely.</p> <p>Remove the pipe/tubing from the tool, and apply a light coating of grease to the face of the lower roll backstop flange, as needed.</p>
During grooving, loud thumps or bangs occur approximately once every revolution of the pipe/tubing.	<p>Pipe/tubing has a pronounced weld seam.</p>	<p>Grind the raised welds flush with the interior and exterior pipe/tubing surfaces 2 inches (50 mm) back from the pipe/tubing end.</p>

Problem	Possible Cause	Solution
Pipe/tubing flare is excessive.	<p>Pipe/tubing support adjusted too high for long pipe/tubing.</p> <p>Tool is tilted forward (out of level) while grooving long pipe/tubing.</p> <p>Incorrect pipe/tubing support positioning of long pipe/tubing. Pipe/tubing is "over-tracking".</p> <p>Pipe stabilizer is adjusted too far inward.</p>	<p>Refer to the "Long Pipe/Tubing Lengths" section on page 13.</p> <p>Refer to the "Tool Setup" section on page 7.</p> <p>Move the pipe support to the right. Refer to the "Long Pipe/Tubing Lengths" section on page 13.</p> <p>Back off the pipe stabilizer to the furthest point where it still stabilizes the pipe effectively.</p>
Larger diameter pipe sways or vibrates from side to side.	<p>Incorrect pipe stabilizer adjustment.</p> <p>Optional pipe stabilizer was not purchased, installed, or used.</p>	<p>Move the pipe stabilizer in or out until the pipe rotates smoothly.</p> <p>Purchase, install, or use the optional pipe stabilizer.</p>
The tool will not groove the pipe/tubing.	<p>Hand pump valve is not closed tightly.</p> <p>Hand pump is low on oil.</p> <p>Air is present in the hydraulic system.</p> <p>Pipe/tubing is beyond the wall thickness capacity of the tool.</p>	<p>Tighten the hand pump valve by turning the knob clockwise.</p> <p>Refer to the "Maintenance" section on page 32.</p> <p>Refer to the "Maintenance" section on page 32.</p> <p>Refer to the "Tool Rating and Roll Selection" section, starting on page 39.</p>
Pipe/tubing grooves do not meet Victaulic specifications.	<p>Groove diameter stop is not adjusted correctly.</p> <p>Pipe/tubing is beyond the wall thickness capacity of the tool.</p>	<p>Refer to the "Groove Diameter Stop Adjustment" section on page 18.</p> <p>Refer to the "Tool Rating and Roll Selection" section, starting on page 39.</p>
The "A" Gasket Seat or "B" Groove Width dimensions do not meet Victaulic specifications.	<p>Upper roll bearing is not lubricated adequately.</p> <p>Incorrect upper roll, lower roll, or both installed on the tool.</p>	<p>Refer to the "Maintenance" section, starting on page 32.</p> <p>Install the correct rolls. Refer to the "Tool Rating and Roll Selection" section, starting on page 39.</p>

TOOL RATING AND ROLL SELECTION

STANDARD AND “ES” ROLLS FOR STEEL AND STAINLESS STEEL PIPE – COLOR-CODED BLACK

(For 2 - 12-inch lightwall stainless steel pipe, refer to the table on page 41)

Pipe Size		Dimensions – inches/millimeters				Standard Roll Part Numbers	“ES” Roll Part Numbers
		Steel Pipe Wall Thickness		Stainless Steel Pipe Wall Thickness			
Nominal Size inches or mm	Actual Out. Diameter inches (mm)	Minimum	Maximum	Minimum	Maximum		
3/4	1.050 26,9	0.065 1,7	0.113 2,9	0.065 1,7	0.113 2,9	Lower Roll R9A0268L01 Upper Roll R9A0268U02	NOT APPLICABLE
1	1.315 33,7	0.065 1,7	0.133 3,4	0.065 1,7	0.133 3,4	Lower Roll R9A1268L02 Upper Roll R9A0268U02	NOT APPLICABLE
1 1/4	1.660 42,4	0.065 1,7	0.140 3,6	0.065 1,7	0.140 3,6		
1 1/2	1.900 48,3	0.065 1,7	0.145 3,7	0.065 1,7	0.145 3,7		
2	2.375 60,3	0.065 1,7	0.154 3,9	0.154 3,9	0.154 3,9	Lower Roll R902272L03 Upper Roll R9A2268U06	Lower Roll RZ02272L03 Upper Roll RZA2268U03
2 1/2	2.875 73,0	0.083 2,1	0.203 5,2	0.203 5,2	0.203 5,2		
3	3.500 88,9	0.083 2,1	0.216 5,5	0.216 5,5	0.216 5,5		
3 1/2	4.000 101,6	0.083 2,1	0.226 5,7	0.226 5,7	0.226 5,7		
4	4.500 114,3	0.083 2,1	0.237 6,0	0.237 6,0	0.237 6,0	Lower Roll R904272L06 Upper Roll R9A2268U06	Lower Roll RZ04272L06 Upper Roll RZA4268U06
4 1/2	5.000 127,0	0.095 2,4	0.237 6,0	0.237 6,0	0.237 6,0		
5	5.563 141,3	0.109 2,8	0.258 6,6	0.258 6,6	0.258 6,6		
152,4 mm	6.000 152,4	0.109 2,8	0.258 6,6	0.258 6,6	0.258 6,6		
6	6.625 168,3	0.109 2,8	0.280 7,1	0.280 7,1	0.280 7,1		
203,2 mm	8.000 203,2	0.109 2,8	0.322 8,2	0.250 6,4	0.322 8,2	Lower Roll R908272L12 Upper Roll R9A8268U12	Lower Roll RZ08272L12 Upper Roll RZA8268U12
8	8.625 219,1	0.109 2,8	0.322 8,2	0.250 6,4	0.322 8,2		
10	10.750 273,0	0.134 3,4	0.250 6,4	0.250 6,4	0.250 6,4		
12	12.750 323,9	0.156 4,0	0.250 6,4	0.250 6,4	0.250 6,4		

Notes:

Column 1: Maximum ratings on steel are limited to pipe of a Brinell Hardness Number (BHN) of 180 BHN and less
Column 2: Types 304/304L and 316/316L stainless steel pipe

The wall thicknesses listed are nominal minimum and maximum

In addition, the following pipe sizes may be roll grooved: 76,1 mm; 108,0 mm; 127,0 mm; 133,0 mm; 139,7 mm; 159,0 mm; 165,1 mm; 216,3 mm; 267,4 mm; and 318,5 mm. Contact Victaulic Tool Company for details.

**ROLLS FOR ALUMINUM AND PVC PLASTIC PIPE –
COLOR-CODED YELLOW ZINC**

Pipe Size		1		2		Standard Roll Part Numbers
		Dimensions – inches/millimeters				
Nominal Size inches or mm	Actual Outside Diameter inches (mm)	Aluminum Pipe Wall Thickness		PVC Plastic Pipe Wall Thickness		
		Minimum	Maximum	Minimum	Maximum	
2	2,375 60,3	0.065 1,7	0.154 3,9	0.154 3,9	0.154 3,9	Lower Roll R902272L03
2½	2,875 73,0	0.083 2,1	0.203 5,2	0.203 5,2	0.276 7,0	
3	3,500 88,9	0.083 2,1	0.216 5,5	0.216 5,5	0.300 7,6	
3½	4,000 101,6	0.083 2,1	0.226 5,7	0.226 5,7	0.318 8,1	Upper Roll RP02272U06
4	4,500 114,3	0.083 2,1	0.237 6,0	0.237 6,0	0.337 8,6	Lower Roll R902272L06 Upper Roll RP02272U06
4½	5,000 127,0	0.095 2,4	0.237 6,0	- -	- -	
5	5,563 141,3	0.109 2,8	0.258 6,6	0.258 6,6	0.375 9,5	
152,4 mm	6,000 152,4	0.109 2,8	0.258 6,6	- -	- -	
6	6,625 168,3	0.109 2,8	0.280 7,1	0.280 7,1	0.432 11,0	

Notes:

Column 1: Alloys 6061-T4 and 6063-T4

Column 2: PVC Type 1, Grade 1 – PVC 1120; PVC Type 1, Grade II – PVC 1220; PVC Type II, Grade I – PVC 2116

The wall thicknesses listed are nominal minimum and maximum

In addition, the following pipe sizes may be roll grooved: 76,1 mm; 108,0 mm; 133,0 mm; 139,7 mm; 159,0 mm; and 165,1 mm. Contact Victaulic Tool Company for details.

A special lower roll is available for grooving 2-inch Schedule 80 PVC plastic pipe (part number RP02272L02). Contact Victaulic Tool Company for details.

**RX ROLLS FOR SCHEDULE 5S AND 10S STAINLESS STEEL PIPE -
COLOR-CODED SILVER**

Pipe Size		Dimensions – inches/millimeters		RX Roll Part Numbers
Nominal Size inches	Actual Outside Diameter inches (mm)	Stainless Steel Pipe ‡ Wall Thickness		
		Minimum for Schedule 5S	Maximum for Schedule 10S	
2	2.375 60,3	0.065 1,7	0.109 2,8	Lower Roll RX02272L03 Upper Roll RXA2268U06
2½	2.875 73,0	0.083 2,1	0.120 3,0	
3	3.500 88,9	0.083 2,1	0.120 3,0	
3½	4.000 101,6	0.083 2,1	0.120 3,0	
4	4.500 114,3	0.083 2,1	0.120 3,0	Lower Roll RX04272L06 Upper Roll RXA2268U06
5	5.563 141,3	0.109 2,8	0.134 3,4	
6	6.625 168,3	0.109 2,8	0.134 3,4	
8	8.625 219,1	0.109 2,8	0.148 3,8	Lower Roll RX08272L12 Upper Roll RXA8268U12
10	10.750 273,0	0.134 3,4	0.165 4,2	
12	12.750 323,9	0.156 4,0	0.180 4,6	

Notes:

‡ Types 304/304L and 316/316L stainless steel pipe

The wall thicknesses listed are nominal minimum and maximum

In addition, the following pipe sizes may be roll grooved: 76,1 mm; 108,0 mm; 133,0 mm; 139,7 mm; 152,4 mm; 159,0 mm; 165,1 mm; and 203,2 mm. Contact Victaulic Tool Company for details.

ROLLS FOR CTS US STANDARD - ASTM DRAWN COPPER TUBING - COLOR-CODED COPPER

Tube Size		Dimensions – inches/millimeters		Copper Roll Part Numbers
Nominal Size inches	Actual Outside Diameter inches (mm)	Copper Tubing Wall Thickness ‡		
		Minimum	Maximum	
2	2.125	0.042	0.083	Lower Roll RR02272L06 Upper Roll RRA2268U08
	54,0	1,1	2,1	
2½	2.625	0.065	0.095	
	66,7	1,7	2,4	
3	3.125	0.045	0.109	
	79,4	1,1	2,8	
4	4.125	0.058	0.134	
	104,8	1,5	3,4	
5	5.125	0.072	0.160	
	130,2	1,8	4,1	
6	6.125	0.083	0.192	
	155,6	2,1	4,9	
8	8.125	0.109	0.271	Lower Roll RR08272L08
	206,4	2,8	6,9	

‡ ASTM B306, Type DWV and ASTM B88, Types K, L, M copper tubing
The wall thicknesses listed are nominal minimum and maximum

ROLLS FOR EUROPEAN STANDARD – EN 1057 DRAWN COPPER TUBING – COLOR-CODED COPPER

Nominal Size mm	Dimensions – millimeters (inches)		Copper Roll Part Numbers
	Copper Tubing Wall Thickness		
	Minimum	Maximum	
54,0	1,2	2,0	Lower Roll RRE1272L06 Upper Roll RRE1272U06
	0.047	0.079	
64,0	2,0	2,0	
	0.079	0.079	
66,7	1,2	2,0	
	0.047	0.079	
76,1	1,5	2,0	
	0.059	0.079	
88,9	2,0	2,0	
	0.079	0.079	
108,0	1,5	2,5	
	0.059	0.098	
133,0	1,5	3,0	
	0.059	0.118	
159,0	2,0	3,0	
	0.079	0.118	

NOTE: The European Standard (EN 1057) replaces the British Standard (BS 2871) and DIN Standard (DIN 1786). However, to ensure proper product performance, refer to Tables X and Y in the British Standard (BS 2871).

**ROLLS FOR AUSTRALIAN STANDARD – AS 1432 DRAWN COPPER TUBING –
COLOR CODED COPPER**

Nominal Size mm	Dimensions – millimeters (inches)		Copper Roll Part Numbers
	Copper Tubing Wall Thickness ‡		
	Minimum	Maximum	
DN 50	0,9 0.035	1,6 0.063	Lower Roll RRE1272L06 Upper Roll RRE1272U06
DN 65	0,9 0.035	1,6 0.063	
DN 80	1,2 0.047	2,0 0.079	
DN 100	1,2 0.047	2,0 0.079	
DN 125	1,4 0.055	2,0 0.079	
DN 150	1,6 0.063	2,6 0.102	

‡ Types A, B, and D

EXPLANATION OF CRITICAL ROLL GROOVE DIMENSIONS

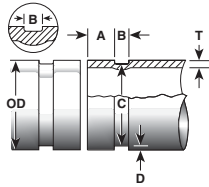

Standard Roll Groove

Outside Diameter (“OD”) Dimension – The outside diameter of roll grooved pipe must not vary from the specifications listed in the following tables. The maximum allowable tolerance from square-cut pipe ends is 0.030 inch (0,8 mm) for $\frac{3}{4}$ - $3\frac{1}{2}$ -inch sizes; 0.045 inch (1,1 mm) for 4 – 6-inch sizes; and 0.060 inch (1,5 mm) for 203,2 mm and larger sizes. This is measured from the true square line.

“A” Dimension – The “A” dimension, or the distance from the pipe end to the groove, identifies the gasket seating area. This area must be free from indentations, projections, and roll marks from the pipe end to the groove to provide a leak-tight seal for the gasket.

“B” Dimension – The “B” dimension, or groove width, controls expansion and angular deflection by the distance it is located from the pipe and its width in relation to the housings’ “key” width.

“C” Dimension – The “C” dimension is the proper diameter at the base of the groove. This dimension must be within the diameter’s tolerance and concentric with the OD for proper coupling fit. The groove must be of uniform depth for the entire pipe circumference.

“D” Dimension – The “D” dimension is the normal depth of the groove and is a reference for a “trial groove” only. Variations in pipe OD affect this dimension and must be altered, if necessary, to keep the “C” dimension within tolerance. **This groove must conform to the “C” dimension.**

“F” Dimension (Standard Roll Groove Only) – Maximum allowable pipe-end flare diameter is measured at the extreme pipe-end diameter.

“T” Dimension – The “T” dimension is the lightest grade (minimum, nominal wall thickness) of pipe that is suitable for roll grooving (except for PVC pipe).

ROLL GROOVE SPECIFICATIONS

STEEL, STAINLESS STEEL, ALUMINUM, AND PVC PIPE

Pipe Size		Dimensions – Inches (millimeters)												
Nominal Size inches or mm	Actual OD Inches (mm)	Pipe Outside Diameter		Gasket Seat "A"		Groove Width "B"				Groove Diameter "C"		Groove Depth "D" (ret.)	Min. Allow. Wall Thick. "T"	Max. Allow. Flare Dia. "F"
		Max.	Min.	Basic	Max.	Basic	Max.	Min.	Max.	Min.	Max.			
3/4	1.050	1.060	1.040	0.625	0.656	0.594	0.281	0.312	0.250	0.938	0.923	0.056	0.049	1.15
	26.9	26.4	26.9	15.9	16.7	15.1	7.1	7.9	6.4	23.8	23.4	1.5	1.2	29.2
1	1.315	1.328	1.302	0.625	0.656	0.594	0.281	0.312	0.250	1.190	1.175	0.063	0.049	1.43
	33.7	33.7	33.1	15.9	16.7	15.1	7.1	7.9	6.4	30.2	29.9	1.6	1.2	36.3
1 1/4	1.660	1.676	1.644	0.625	0.656	0.594	0.281	0.312	0.250	1.535	1.520	0.063	0.049	1.77
	42.4	42.6	41.8	15.9	16.7	15.1	7.1	7.9	6.4	39.0	38.6	1.6	1.2	45.0
1 1/2	1.900	1.919	1.881	0.625	0.656	0.594	0.281	0.312	0.250	1.775	1.760	0.063	0.049	2.01
	48.3	48.7	47.8	15.9	16.7	15.1	7.1	7.9	6.4	45.1	44.7	1.6	1.2	51.1
2	2.375	2.399	2.351	0.625	0.656	0.594	0.344	0.375	0.313	2.250	2.235	0.063	0.049	2.48
	60.3	60.9	59.7	15.9	16.7	15.1	8.7	9.5	8.0	57.2	56.8	1.6	1.2	63.0
2 1/2	2.875	2.904	2.846	0.625	0.656	0.594	0.344	0.375	0.313	2.720	2.702	0.078	0.078	2.98
	73.0	73.8	72.3	15.9	16.7	15.1	8.7	9.5	8.0	69.1	68.6	2.0	2.0	75.7
76.1 mm	3.000	3.030	2.970	0.625	0.656	0.594	0.344	0.375	0.313	2.845	2.827	0.078	0.078	3.10
	76.1	77.0	75.4	15.9	16.7	15.1	8.7	9.5	8.0	72.3	71.8	2.0	2.0	78.7
3	3.500	3.535	3.469	0.625	0.656	0.594	0.344	0.375	0.313	3.344	3.326	0.078	0.078	3.60
	88.9	89.8	88.1	15.9	16.7	15.1	8.7	9.5	8.0	84.9	84.5	2.0	2.0	91.4
3 1/2	4.000	4.040	3.969	0.625	0.656	0.594	0.344	0.375	0.313	3.834	3.814	0.083	0.078	4.10
	101.6	102.6	100.8	15.9	16.7	15.1	8.7	9.5	8.0	97.4	96.9	2.2	2.0	104.1
108.0 mm	4.250	4.293	4.219	0.625	0.656	0.594	0.344	0.375	0.313	4.084	4.064	0.083	0.078	4.35
	108.0	109.0	107.2	15.9	16.7	15.1	8.7	9.5	8.0	103.7	103.2	2.2	2.0	110.5
4	4.500	4.545	4.469	0.625	0.656	0.594	0.344	0.375	0.313	4.334	4.314	0.083	0.078	4.60
	114.3	115.4	113.5	15.9	16.7	15.1	8.7	9.5	8.0	110.1	109.6	2.2	2.0	116.8
4 1/2	5.000	5.050	4.969	0.625	0.656	0.594	0.344	0.375	0.313	4.834	4.814	0.083	0.078	5.10
	127.0	128.3	126.2	15.9	16.7	15.1	8.7	9.5	8.0	122.8	122.3	2.2	2.0	129.5
133.0 mm	5.250	5.303	5.219	0.625	0.656	0.594	0.344	0.375	0.313	5.084	5.064	0.083	0.078	5.35
	133.0	134.7	132.6	15.9	16.7	15.1	8.7	9.5	8.0	129.1	128.6	2.2	2.0	135.9
139.7 mm	5.500	5.556	5.469	0.625	0.656	0.594	0.344	0.375	0.313	5.334	5.314	0.083	0.078	5.60
	139.7	141.1	138.9	15.9	16.7	15.1	8.7	9.5	8.0	135.5	135.0	2.2	2.0	142.2
5	5.563	5.619	5.532	0.625	0.656	0.594	0.344	0.375	0.313	5.395	5.375	0.084	0.078	5.66
	141.3	142.7	140.5	15.9	16.7	15.1	8.7	9.5	8.0	137.0	136.5	2.2	2.0	143.8

ROLL GROOVE SPECIFICATIONS

STEEL, STAINLESS STEEL, ALUMINUM, AND PVC PIPE

Pipe Size		Dimensions – inches (millimeters)													
Nominal Size inches or mm	Actual OD inches (mm)	Pipe Outside Diameter		Gasket Seat "A"		Groove Width "B"			Groove Diameter "C"		Groove Depth "D" (ref.)	Min. Allow. Wall Thick. "T"	Max. Allow. Flare Dia. "F"		
		Max.	Min.	Basic	Max.	Min.	Basic	Max.	Min.	Max.				Min.	
152,4 mm	6.000	6.056	5.969	0.625	0.656	0.594	0.344	0.375	0.313	5.808	0.085	0.078	6.10		
	152,4	153,8	151,6	15,9	16,7	15,1	8,7	9,5	8,0	147,5	2,2	2,0	154,9		
159,0 mm	6.250	6.313	6.219	0.625	0.656	0.594	0.344	0.375	0.313	6.002	0.109	0.109	6.35		
	159,0	160,4	158,0	15,9	16,7	15,1	8,7	9,5	8,0	152,5	2,8	2,8	161,3		
165,1 mm	6.500	6.563	6.469	0.625	0.656	0.594	0.344	0.375	0.313	6.308	0.085	0.078	6.60		
	165,1	166,7	164,3	15,9	16,7	15,1	8,7	9,5	8,0	160,2	2,2	2,0	167,6		
6	6.625	6.688	6.594	0.625	0.656	0.594	0.344	0.375	0.313	6.455	0.085	0.078	6.73		
	168,3	169,9	167,5	15,9	16,7	15,1	8,7	9,5	8,0	164,0	2,2	2,8	170,9		
203,2 mm	8.000	8.063	7.969	0.750	0.781	0.719	0.469	0.500	0.438	7.816	0.092	0.109	8.17		
	203,2	204,8	202,4	19,1	19,8	18,3	11,9	12,7	11,1	198,5	2,4	2,8	207,5		
216,3 mm	8.515	8.578	8.484	0.750	0.781	0.719	0.469	0.500	0.438	8.306	0.092	0.109	8.69		
	216,3	217,9	215,5	19,1	19,8	18,3	11,9	12,7	11,1	211,6	2,4	2,8	220,7		
8	8.625	8.688	8.594	0.750	0.781	0.719	0.469	0.500	0.438	8.441	0.092	0.109	8.80		
	219,1	220,7	218,3	19,1	19,8	18,3	11,9	12,7	11,1	214,4	2,4	2,8	223,5		
254,0 mm	10.000	10.063	9.969	0.750	0.781	0.719	0.469	0.500	0.438	9.812	0.094	0.134	10.17		
	254,0	255,6	253,2	19,1	19,8	18,3	11,9	12,7	11,1	248,5	2,4	3,4	258,3		
267,4 mm	10.528	10.591	10.497	0.750	0.781	0.719	0.469	0.500	0.438	10.313	0.094	0.134	10.70		
	267,4	269,0	266,6	19,1	19,8	18,3	11,9	12,7	11,1	262,6	2,4	3,4	271,8		
10	10.750	10.813	10.719	0.750	0.781	0.719	0.469	0.500	0.438	10.562	0.094	0.134	10.92		
	273,0	274,7	272,3	19,1	19,8	18,3	11,9	12,7	11,1	268,3	2,4	3,4	277,4		
304,8 mm	12.000	12.063	11.969	0.750	0.781	0.719	0.469	0.500	0.438	11.781	0.109	0.156	12.17		
	304,8	306,4	304,0	19,1	19,8	18,3	11,9	12,7	11,1	299,2	2,8	4,0	309,1		
318,5 mm	12.539	12.602	12.508	0.750	0.781	0.719	0.469	0.500	0.438	12.321	0.109	0.156	12.71		
	318,5	320,1	317,7	19,1	19,8	18,3	11,9	12,7	11,1	313,0	2,8	4,0	322,8		
12	12.750	12.813	12.719	0.750	0.781	0.719	0.469	0.500	0.438	12.531	0.109	0.156	12.92		
	323,9	325,5	323,1	19,1	19,8	18,3	11,9	12,7	11,1	318,3	2,8	4,0	328,2		

ROLL GROOVE SPECIFICATIONS

STEEL PIPE AND ALL MATERIALS GROOVED WITH "ES" ROLLS

Nominal Size inches or mm	Pipe Size		Dimensions – inches (millimeters)												Min. Allow. Wall Thick. "T"	Max. Allow. Flare Dia. "F"
	Act. Out. Dia. inches (mm)	Pipe Outside Diameter		Gasket Seat "A"		Groove Width "B"				Groove Diameter "C"		Groove Depth "D" (ref.)				
		Max.	Min.	Max.	Min.	Max.	Min.	Max.	Min.	Max.	Min.		Max.			
2	2.375 60.3	2.351	0.552	0.265	0.250	2.235	0.063	2.480	0.154 3.9	63.0						
		60.9	14.5	6.7	6.4	57.2	1.6	63.0								
2 1/2	2.875 73.0	2.846	0.552	0.265	0.250	2.702	0.078	2.980	0.203 5.2	75.7						
		73.8	14.5	6.7	6.4	68.6	2.0	75.7								
3	3.500 88.9	3.469	0.552	0.265	0.250	3.326	0.083	3.600	0.216 5.5	91.4						
		89.8	14.5	6.7	6.4	84.9	2.1	91.4								
4	4.500 114.3	4.469	0.590	0.320	0.300	4.314	0.083	4.600	0.237 6.0	116.8						
		115.4	15.5	8.1	7.6	109.6	2.1	116.8								
6	6.625 168.3	6.688	0.590	0.320	0.300	6.433	0.085	6.730	0.280 7.1	170.9						
		169.9	15.5	8.1	7.6	164.0	2.2	170.9								
8	8.625 219.1	8.688	0.699	0.410	0.390	8.441	0.092	8.800	0.322 8.2	223.5						
		220.7	18.3	10.4	9.9	214.4	2.3	223.5								
10	10.750 273.0	10.813	0.699	0.410	0.390	10.562	0.094	10.920	0.365 9.3	277.4						
		274.7	18.3	10.4	9.9	268.3	2.4	277.4								
12	12.750 323.9	12.813	0.699	0.410	0.390	12.531	0.109	12.920	0.375 9.5	328.2						
		325.5	18.3	10.4	9.9	318.3	2.8	328.2								

ROLL GROOVE SPECIFICATIONS

COPPER TUBING TO CTS US STANDARD – ASTM B-88 AND ASTM B-306

Copper Tubing Size		Dimensions – inches/millimeters													
		Copper Tubing Outside Diameter †				Gasket Seat "A"		Groove Width "B"		Groove Diameter "C"		Groove Depth "D" (Ref. Only)	Min. Allow. Wall Thick. "T"	Max. Allow. Flare Dia. "F"	
		Max.	Min.	Basic	Max.	Min.	Max.	Min.	Max.	Min.					
2	2.127	2.123	0.610	0.640	0.580	0.330	0.300	2.029	2.009	0.048	DWW*	2.220			
54.0	54.0	53.9	15.5	16.3	14.7	8.4	7.6	51.5	51.0	1.2		56.4			
2 1/2	2.627	2.623	0.610	0.640	0.580	0.330	0.300	2.525	2.505	0.050	0.065	2.720			
66.7	66.7	66.6	15.5	16.3	14.7	8.4	7.6	64.1	63.6	1.2	1.7	69.1			
3	3.127	3.123	0.610	0.640	0.580	0.330	0.300	3.025	3.005	0.050	DWW*	3.220			
79.4	79.4	79.3	15.5	16.3	14.7	8.4	7.6	76.8	76.3	1.2		81.8			
4	4.127	4.123	0.610	0.640	0.580	0.330	0.300	4.019	3.999	0.053	DWW*	4.220			
104.8	104.8	104.7	15.5	16.3	14.7	8.4	7.6	102.1	101.6	1.4		107.2			
5	5.127	5.123	0.610	0.640	0.580	0.330	0.300	4.999	4.979	0.063	DWW*	5.220			
130.2	130.2	130.1	15.5	16.3	14.7	8.4	7.6	127.0	126.5	1.6		132.6			
6	6.127	6.123	0.610	0.640	0.580	0.330	0.300	5.999	5.979	0.063	DWW*	6.220			
155.6	155.6	155.5	15.5	16.3	14.7	8.4	7.6	152.3	151.9	1.6		158.0			
8	8.127	8.121	0.610	0.640	0.580	0.330	0.300	7.959	7.939	0.083	DWW*	8.220			
206.4	206.4	206.3	15.5	16.3	14.7	8.4	7.6	202.2	201.7	2.1		208.8			

† The outside diameter of roll grooved copper tubing cannot vary from the tolerance listed. The maximum allowable tolerance from square cut ends is 0.030 inch (0.8 mm) for 2- 3 inch (54.0 – 79.4 mm) sizes and 0.045 inch (1.1 mm) for 4- 6 inch (104.8 – 155.6 mm) sizes; this is measured from the true square line.

* ASTM B-306 drain-waste and vent (DWV) is the minimum wall thickness or copper tubing that can be roll grooved.

ROLL GROOVE SPECIFICATIONS

COPPER TUBING TO EUROPEAN STANDARD – EN 1057

Actual Size mm ‡	Dimensions – millimeters/inches										
	Actual OD *		Gasket Seat "A"			Groove Width "B"		Groove Diameter "C"		Groove Depth "D" (Ref. Only)	Max. Allow. Flare Dia. "F"
	Max.	Min.	Basic	Max.	Min.	Max.	Min.	Max.	Min.		
54	54,07 2.129	53,93 2.123	15,87 0.625	16,64 0.655	15,11 0.595	8,38 0.330	7,62 0.300	51,51 2.028	51,00 2.008	1,25 0.049	56,39 2.220
64	64,07 2.522	63,93 2.517	15,87 0.625	16,64 0.655	15,11 0.595	8,38 0.330	7,62 0.300	61,47 2.420	60,96 2.400	1,27 0.050	66,41 2.615
66,7	66,77 2.629	66,63 2.623	15,87 0.625	16,64 0.655	15,11 0.595	8,38 0.330	7,62 0.300	64,14 .525	63,63 2.505	1,27 0.050	69,09 2.720
76,1	76,17 2.999	76,03 2.993	15,87 0.625	16,64 0.655	15,11 0.595	8,38 0.330	7,62 0.300	73,41 2.890	72,90 2.870	1,35 0.053	78,61 3.095
88,9	88,97 3.496	88,83 3.497	15,87 0.625	16,64 0.655	15,11 0.595	8,38 0.330	7,62 0.300	85,70 3.374	85,19 3.354	1,60 0.063	91,63 3.607
108	108,07 4.255	107,93 4.249	15,87 0.625	16,64 0.655	15,11 0.595	8,38 0.330	7,62 0.300	104,80 4.126	104,29 4.106	1,60 0.063	110,54 4.352
133	133,20 5.244	132,80 5.228	15,87 0.625	16,64 0.655	15,11 0.595	8,38 0.330	7,62 0.300	129,29 5.090	128,78 5.070	1,85 0.073	135,79 5.346
159	159,20 6.280	158,80 6.252	15,87 0.625	16,64 0.655	15,11 0.595	8,38 0.330	7,62 0.300	155,30 6.114	154,79 6.094	1,85 0.073	161,80 6.370

‡ European Standard Copper Tubing; Nominal EN 1057 drawn copper tubing size

* The outside diameter of roll grooved copper tubing cannot vary from the tolerance listed. The maximum allowable tolerance from square cut ends is 0,8 mm (0.030 inch) for 54 – 88,9 mm sizes and 1,1 mm (0.045 inch) for 108 – 159 mm sizes; this is measured from the true square line.

COPPER TUBING TO AUSTRALIAN STANDARD – AS 1432

Nominal Size mm ‡	Dimensions – millimeters/inches										
	Actual OD *		Gasket Seat "A"			Groove Width "B"		Groove Diameter "C"		Groove Depth "D" (Ref. Only)	Max. Allow. Flare Dia. "F"
	Max.	Min.	Basic	Max.	Min.	Max.	Min.	Max.	Min.		
DN 50	50,80 2.000	50,67 1.995	15,87 0.625	16,64 0.655	15,11 0.595	8,38 0.330	7,62 0.300	48,21 1.898	47,70 1.878	1,25 0.049	53,06 2.089
DN 65	63,50 2.500	63,35 2.494	15,87 0.625	16,64 0.655	15,11 0.595	8,38 0.330	7,62 0.300	60,88 2.397	60,38 2.377	1,27 0.050	65,83 2.592
DN 80	76,20 3.000	76,02 2.993	15,87 0.625	16,64 0.655	15,11 0.595	8,38 0.330	7,62 0.300	73,56 2.896	73,05 2.876	1,27 0.050	78,51 3.091
DN 100	101,60 4.000	101,35 3.990	15,87 0.625	16,64 0.655	15,11 0.595	8,38 0.330	7,62 0.300	98,78 3.889	98,27 3.869	1,35 0.053	103,88 4.090
DN 125	127,00 5.000	126,75 4.990	15,87 0.625	16,64 0.655	15,11 0.595	8,38 0.330	7,62 0.300	123,67 4.869	123,16 4.849	1,60 0.063	128,77 5.070
DN 150	152,40 6.000	152,10 5.988	15,87 0.625	16,64 0.655	15,11 0.595	8,38 0.330	7,62 0.300	149,05 5.868	148,54 5.848	1,60 0.063	154,66 6.089

‡ Nominal AS 1432 drawn copper tubing size

* The outside diameter of roll grooved copper tubing cannot vary from the tolerance listed. The maximum allowable tolerance from square cut ends is 0,8 mm (0.030 inch) for DN 50 – 80 mm sizes and 1,1 mm (0.045 inch) for DN 100 – 150 mm sizes; this is measured from the true square line.



Victaulic Tool Company
Tool Shipments:
1326 Tatamy Road, Easton, PA 18045-7400
Sales & Lease Payments:
P.O. Box 8538-244, Phila., PA 19171-0244

Victaulic Companies

CUSTOMER CARE CENTER

Phone: 1-800-PICK-VIC (1-800-742-5842)
FAX: 610/923-3090
e-mail: pickvic@victaulic.com

VICTAULIC TOOL COMPANY

P.O. Box 31 • Easton, PA 18044-0031
Phone: 610/559-3300 • Fax: 610/923-3090
e-mail: victools@victaulic.com

WORLD HEADQUARTERS

P.O. Box 31 • Easton, PA 18044-0031
4901 Kesslersville Road • Easton, PA 18040 USA
Phone: 610/559-3300 • Fax: 610/250-8817

VICTAULIC CONSTRUCTION PIPING SERVICES DIV.

1818 Vultee Street • Allentown, PA 18103
Phone: 610/559-3488 • Fax: 610/923-3170
e-mail: cps@victaulic.com

Victaulic Around the World

VICTAULIC COMPANY OF AMERICA

P.O. Box 31 • Easton, PA 18044-0031
Phone: 610/559-3300 • Fax: 610/250-8817
e-mail: victaulic@victaulic.com

VICTAULIC COMPANY OF CANADA

123 Newkirk Road • Richmond Hill, ON L4C 3G5
Phone: 905/884-7444 • Fax: 905/884-9774
e-mail: viccanada@victaulic.com

VICTAULIC AMERICA LATINA

P.O. Box 31 • Easton, PA USA 18044-0031
4901 Kesslersville Road • Easton, PA USA 18040
Phone: 610/559-3300 • Fax: 610/559-3608
e-mail: vical@victaulic.com

VICTAULIC EUROPE

Prijkelstraat 36 • 9810 Nazareth, Belgium
Phone: 32-9-381-15-00 • Fax: 32-9-380-44-38
e-mail: viceuro@victaulic.be

VICTAULIC ASIA-PACIFIC

541 Orchard Road • #14-02, Liat Towers
Singapore 238881
Phone: 65-6235-3035 • Fax: 65-6235-0535
e-mail: vicap@victaulic.com

www.victaulic.com